

LED LAMPS
& DOWNLIGHT
RETROFITS



SATCO LED LAMPS



SATCO LED lamps offer one of today's largest selections of LED products — providing solutions for the commercial, industrial and residential markets.

We bring quality, value and design to every product we create. With advancing technology, we improve performance, energy savings, safety, ease of installation and maintenance, and overall satisfaction.

We are your partners in success — from convenient packaging options and retail support to inventory supply.

SATCO is the lighting solution you can count on for the products you can rely on!



We do the LIGHT thing. We do the RIGHT thing.™

SATCO is your a single source solution for all of your lighting needs, from emerging LED technologies to decorative fixtures and lighting components, we carry products for nearly every industry and application.

As a turnkey lighting operation, SATCO brings efficiency, value and an ease of doing business to our customers.

Independent and privately owned for over 50 years, SATCO continues to grow because of our traditional values: trust, quality, loyalty and hard work. Agile in practice, unwavering in customer focus...



50+ YEARS IN
BUSINESS

100% INDEPENDENT
PRIVATELY OWNED

15,000+
PRODUCTS

2 MILLION SQ. FT.
OF INVENTORY

6 WAREHOUSE
LOCATIONS

**...we deliver on
product, promise
& partnership.**



LED FILAMENT & DECORATIVE LAMPS

The popularity of the exposed bulb in lighting design continues the evolution in filament lamp design. From new shapes in the filament and structure to amber toned, silver domed and frosted lamps.

Advanced technologies improve energy efficiency, enhance light quality, expand damp and wet location options and offer new lamps in a variety of bases.

Plus, new packaging alternatives are available for your convenience.



GENERAL SERVICE LAMPS

SATCO's vast offering of LED lamps continues to grow with technologies that help retrofit fixtures in nearly every setting.

Our lamps provide significant energy efficiency while preserving the look and feel traditional bulbs.

We are committed to our customers at every level of business, from retail display packaging, single bulb packs, to contractor's packs for convenience.

All with the quality and assurance you can be confident in.



BR & REFLECTOR LAMPS

SATCO's 2020 offering of LED BR & PAR lamps includes improved efficiency, higher CRI and greater values -- all in a significantly broader range! From our expanded line of GEN2 PAR Silver PARs to our new generation of high lumen and range voltage industrial and commercial PAR lamps; to new choices in MR11 and MR16 lamps, the solutions just keep growing!



We do the LIGHT thing. We do the RIGHT thing.



DOWNLIGHT RETROFITS

SATCO's LED vast line of recessed downlight retrofits offers options in various aesthetics, improved efficiency, and easy installation.

The new generations include additional sizes, finishes and features include gimbals and CCT selectable options.

Retrofit downlights remain one of SATCO's most popular categories of lighting for their value and convenience.



HI-PRO HID REPLACEMENTS

Advancements in our commercial and industrial line of High Lumen Professional Grade lamps continue. From quality of light including higher efficiency to design improvements featuring lighter body weight, advanced heat dissipation and increased internal surge protection -- they just keep getting better.

Plus, many of SATCO's lamps offer add-on sensors and smart options. Large scale lighting projects just got easier!

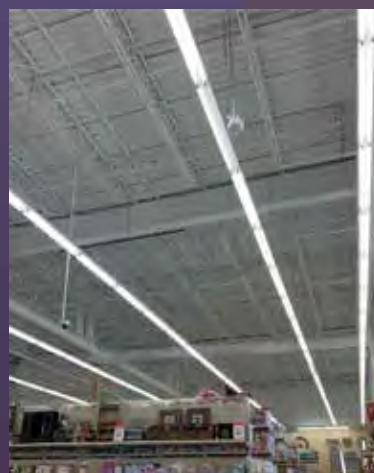

CFL & LINEAR FLUORESCENT REPLACEMENT

SATCO's CFL and linear replacement options continue to focus on safety, light quality and the ease of installation when it comes to replacing traditional CFL and linear bulbs.

SATCO's broad line of CFL and linear replacement options for traditional fixture retrofits provide solutions to help bridge your customers' needs into tomorrow

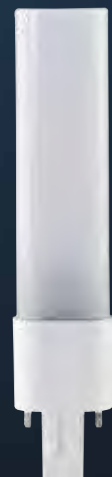

We do the LIGHT thing. We do the RIGHT thing.

About Satco	2-5	Silicon LED Replacements for Halogen G4, G6.35, G8 and G9 Lamps.....	59
LED FILAMENT LAMPS	7-24	Silicon LED Replacements for Halogen E11, E12, BA15D, and BA15S Lamps.....	60
LED Filament Lamps 40W Replacement A15.....	7	DOWNLIGHT RETROFITS	63-70
LED Filament Lamps 40W Replacement A19.....	7	4", 5/6" LED Recessed Downlight Retrofits with	
LED Filament Lamps 60W Replacement A19.....	8	Selectable Color Temperature Settings.....	63
LED Filament Lamps Single Packs.....	9	4" LED Recessed Downlight Retrofits.....	64
LED Filament Lamps Multi-Packs.....	10	5/6" LED Recessed Downlight Retrofits.....	65
LED Filament Lamps Globes - 16½".....	11	5/6" LED Recessed Downlight Retrofits.....	66
LED Filament Lamps Globes - G25.....	12	12V LED Recessed Downlight Retrofits.....	67
LED Filament Lamps Globes - G40.....	13	Quick Trim™ 4", 5/6" LED Recessed Downlight Retrofit 2 Packs.....	67
LED Filament Lamps Decorative - Candelabra Base/Torpedo.....	14	4" LED Square Trim Recessed Downlight Retrofits.....	68
LED Filament Lamps Decorative - Medium Base/Torpedo.....	15	5/6" Square Trim Recessed Downlight Retrofits.....	69
LED Filament Lamps Decorative - Flame Tip.....	16	Hi-Pro LED Lamps.....	70
Specialty Filament Lamps.....	17	HI-PRO HID REPLACEMENTS	71-83
LED Filament Lamps Vintage Style.....	18	Hi-Pro 277-347V High Lumen LED Lamps.....	71
LED Filament Lamps Vintage Style - Spiral.....	19	Hi-Pro LED 12-24V Low Voltage Lamps.....	72
LED Filament Lamps Vintage Style - Spiral in HID Envelopes.....	20	Hi-Pro LED Post Top Lamps.....	72
LED Filament Lamps - Carded.....	21-22	Third Generation Hi-Pro LED Multi-Beam Lamps.....	73
Satco-Escent LED Lamps.....	23	60W LED Multi-Beam Utility Light with and without Motion Sensor.....	74
Carded LED Specialty Lamps.....	24	High Voltage Hi-Pro LED Lamps 277V-480V.....	75
LED A-TYPE	25-42	Hi-Pro 360 Lamps.....	76
40W Replacement LED A19 Lamps.....	25	GEN2 Hi-Pro Shoebox Lamp with Smart Port.....	77
60W Replacement LED A19 Lamps.....	26-27	Hi-Pro LED Wall Pack Lamp Series.....	78
Low Voltage 9W LED A19 Lamps.....	27	Hi-Pro LED High Bay/Low Bay Lamps.....	79
60W Replacement LED A19 4 Packs.....	28	Hi-Pro Sensors.....	80
60W Replacement LED A19 Display Packs.....	29	Instant Hi-Bay Fixture.....	81
60W Replacement LED A19 2 Packs Display.....	29	Hi-Pro LED Temporary Work Lights.....	82
60W Replacement LED A19 10 Packs.....	28	Hi-Pro Temporary Construction String Light Set - 50 Ft.....	83
60W Replacement LED A19 100 Piece Contractor Packs.....	30	CFL & LINEAR FL REPLACEMENTS	84-107
75W Replacement LED A19 Lamps.....	31	LED/CFL Ballast Bypass Type B Replacement Lamps	
75W Replacement LED A19 4 Packs.....	32	2-Pin G23, GX23 Base.....	84
100W Replacement LED A19, A21 Lamps.....	33	LED/CFL Dual Mode (Ballast Bypass Type A/Ballast	
100W Replacement LED A19 4 Packs.....	34	Compatible Type B) Lamps.....	85
125W Replacement 120-277V LED A21 Lamps.....	34	LED/CFL Type A Direct Replacement Lamps - 4-Pin (Electronic	
Hi-Pro A21 Lamps.....	35	Ballasts), 2-Pin (Magnetic Ballasts).....	86
Hi-Pro A23 & A25 Lamps.....	36	PL/LED Ballast Bypass Type B Replacement Lamps.....	87
5W Decorative Flame Lamps.....	35	LED/CFL Type A Direct Replacement Lamps 4-Pin (Electronic Ballasts).....	88
60W Replacement LED A19 Dusk to Dawn.....	37	LED/CFL Ballast Bypass Type B Replacement Lamps	
3-Way A19 & A21 Lamps.....	38	2-Pin GX23 Ballast Bypass, GU24 Base, E26 Base.....	89
40W & 60W Candelabra Base Replacement A19 Lamps.....	39	Satco 2G11 PLL 36W & 40W Type B Replacement Lamps.....	90
LED A19 Colors.....	39	Satco 2, 3' & 6" U-Bend LED Type A T8 Lamps.....	91
40W Replacement LED A15 Lamps.....	40	Satco 12W & 15W, 4' LED Type A T8 Lamps.....	92
Decorative LED Lamps.....	41	Linear LED Ballast Bypass Type B T8 Series.....	93
LED Linear T10 Lamps.....	41	Dimmable 13.5W Linear LED T8 Ballast Bypass Type B Lamps.....	94
LED Squat CFL Lamp Replacement with GU24 Base.....	42	Premium LED T8 Ballast Bypass Type B, True Flicker-Free Lamps.....	95
BR & HALOGEN REPLACEMENT LAMPS	43-62	15W Linear LED Ballast Bypass Type B T8 Series.....	96
R20 Reflectors 80 & 90 CRI.....	43	Linear LED Ballast Bypass Type B T8 U-Bend Series.....	96
BR Reflectors 80 & 90 CRI.....	43	Slimline 4', 6', 8' T8 Ballast Bypass Type B Series.....	97
8W BR30 LED 2 Pack Display.....	44	43W Linear LED Ballast Bypass 8' Type B T8 Series.....	97
11.5W & 16.5W BR40 LED Reflectors 80 & 90 CRI.....	44	25W, 4' Linear LED Type A T5 Lamps.....	98
10W BR30 LED Reflector Display Packs & 6 Packs.....	45	Satco LED T5 Type B Ballast Bypass Series.....	98
7W LED PAR20 - Amber.....	45	Satco LED T5 Mini Bi-Pin (G5) Ballast Bypass Type B Series.....	99
Silver PAR - Gen 2 - PAR20.....	46	LED T8 Dual Mode (Ballast Bypass Type B/Ballast Compatible Type A)	
Silver PAR - Gen 2 - PAR30/SN, PAR30/LN.....	47	1-5/8" U-Bend Lamps.....	100
Silver PAR - Gen 2 - PAR38.....	48	LED T8 Dual Mode (Ballast Bypass Type B/Ballast Compatible Type A)	
LED Silver PAR - G1 Series - 7W PAR20 Lamps.....	49	Linear Lamps.....	101
LED Silver PAR - G1 Series - 13W PAR30 Short Neck Lamps.....	50	System Performance - LED T8 Dual Mode Linear - Ballast Compatible.....	102
LED Silver PAR - G1 Series - 13W PAR30 Long Neck Lamps.....	51	Linear LED T8, T5HO Type C System.....	103
15W & 18W LED PAR38 Lamps.....	52	Linear LED T8 Type C Lamps.....	104
Econo LED PAR Lamps.....	53	Linear LED T6 Type C Lamps.....	104
High Lumen LED PAR Lamps.....	54	LED T5 Type C Drivers.....	104
Hi-Pro LED PAR30 Lamps.....	55	8' & 12' T9 LED Ballast Bypass Type B Circeline Lamps.....	105
Hi-Pro LED PAR38 Lamps.....	5	LED Emergency Back-Up.....	106
LED PAR 16 4.5W & 6.5W Lamps.....	56	LED T8 Type B Sign Lamps Extended Line with New Length Options.....	107
1.6W & 3W, 12V LED MR11 Lamps.....	56	LIGHT ENGINE FIXTURE RETROFIT	108
LED MR16 Lamps.....	57	Circular LED Module Retrofit Kits.....	108
MR16 GU10 Base LED Lamps.....	58	SATCO RETAIL SUPPORT	109-110
Carded LED MR Lamps.....	59	INDEX	111-114
LED MR16 E26 Base Lamps.....	60		
LED Elevator Lamps.....	60		

Satco has two lines of product to help you meet California's Building and Appliance codes:

Building Code (Title 24): The full line of Joint Appendix 8 (JA8) lamps are certified to the Title 24 2016 building code. These products will help you comply with the newest California residential building codes.

Appliance Code (Title 20): Lamps and Retrofit Kits are considered appliances in the California Code, and Title 20 is one of the most stringent in the country. Satco has a full line of products that are compliant with this code.

As an ongoing effort on behalf of Satco Products, Inc. to remain dedicated to the improvement of our products, we reserve the right to change specifications. The information contained in this specification guide is subject to change without notice. We cannot be responsible for typographical errors.

LED filament lamps

- LED with a traditional incandescent look and feel
- Omni-directional light source
- Dimmable
- Damp location
- Approved for totally enclosed fixtures**
- c-UL-us listed
- CEC T20/T24 Available
- ENERGY STAR certified*
- 3 Year warranty



S29874
A15



S21102
A15



S8550
A15



LED FILAMENT

LED Filament Lamps - A15 - 40W Replacement

Item Number	Lamp Description	W	Bulb Type	Base	V	Finish	CCT	Lm	CRI	M.O.L. (Inches)	Life/ Hrs.	UPC	Pack
S29874*	5A15/CL/LED/E26/27K/ES/120V	5	A15	E26	120	Clear	2700K	450	80	3 3/8	15K	045923298745	24/6
S21100	5A15/CL/LED/E26/3K/ES/120V	5	A15	E26	120	Clear	3000K	450	80	3 3/8	15K	045923200021	24/6
S21101	5A15/CL/LED/E26/4K/ES/120V	5	A15	E26	120	Clear	4000K	450	80	3 3/8	15K	045923200038	24/6
S21102	5A15/FR/LED/E26/3K/ES/120V	5	A15	E26	120	Frost	3000K	450	80	3 3/8	15K	045923200045	24/6
90 CRI—CEC/T20													
S8550*	5A15/LED/927/CL/120V	5	A15	E26	120	Clear	2700K	450	90	3 3/8	15K	045923085505	24/6
S11350*■	5A15/LED/927/FR/120V	5	A15	E26	120	Frost	2700K	450	90	3 1/2	15K	045923113505	24/6
S11351*■	5A15/LED/930/CL/120V	5	A15	E26	120	Clear	3000K	450	90	3 1/2	15K	045923113512	24/6

■ Also T24 compliant. JA8-2019



S29875
A19



S29824, S21104
A19



LED Filament Lamps - A19 - 40W Replacement

Item Number	Lamp Description	W	Bulb Type	Base	V	Finish	CCT	Lm	CRI	M.O.L. (Inches)	Life/ Hrs.	UPC	Pack
S29875*	5A19/CL/LED/E26/27K/ES/120V	5	A19	E26	120	Clear	2700K	450	80	4 1/8	15K	045923298752	24/6
S21103	5A19/CL/LED/E26/3K/ES/120V	5	A19	E26	120	Clear	3000K	450	80	4 1/8	15K	045923200052	24/6
S29824	5A19/SW/LED/E26/27K/ES/120V	5	A19	E26	120	Soft White	2700K	450	80	4 1/8	15K	045923298240	24/6
S21104	5A19/SW/LED/E26/3K/ES/120V	5	A19	E26	120	Soft White	3000K	450	80	4 1/8	15K	045923201042	24/6
90 CRI—CEC/T20													
S11352*■	5A19/LED/927/CL/120V	5	A19	E26	120	Clear	2700K	450	90	4 3/8	15K	045923113529	24/6
S11354*■	5A19/LED/927/SW/120V	5	A19	E26	120	Soft White	2700K	450	90	4 3/8	15K	045923113543	24/6
S11353*■	5A19/LED/930/CL/120V	5	A19	E26	120	Clear	3000K	450	90	4 3/8	15K	045923113536	24/6

■ Also T24 compliant. JA8-2019

**See warranty for details.

LED filament lamps 60 Watt replacements



S29876, S29894,
S28850, S39879



S39825, S39809



S9826

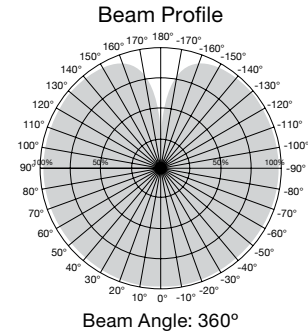

LED Filament Lamps - A19 - 60W Replacement



Item Number	Lamp Description	W	Bulb Type	Base	V	Finish	CCT	Lm	CRI	M.O.L. (Inches)	Life/ Hrs.	UPC	Pack
S29876*	7A19/CL/LED/E26/27K/ES/120V	7	A19	E26	120	Clear	2700K	800	80	4 1/8	15K	045923298769	24/6
S29894	7A19/CL/LED/E26/3K/ES/120V	7	A19	E26	120	Clear	3000K	800	80	4 1/8	15K	045923298943	24/6
S28850*	7A19/CL/LED/E26/4K/ES/120V	7	A19	E26	120	Clear	4000K	800	80	4 1/8	15K	045923288500	24/6
S39825*	7.5A19/SW/LED/E26/27K/120V	7.5	A19	E26	120	Soft White	2700K	800	80	4 1/8	15K	045923398254	24/6
S39809	7.5A19/SW/LED/E26/3K/120V	7.5	A19	E26	120	Soft White	3000K	800	80	4 1/8	15K	045923398094	24/6
S9826†	6.5A19/SLV/LED/E26/27K/120V	6.5	A19	E26	120	Silver Crown	2700K	650	80	4 1/8	15K	045923098260	24/6

90 CRI—CEC/T20													
S39879■	8A19/LED/927/CL/120V	8	A19	E26	120	Clear	2700K	800	90	4 3/8	15K	045923298790	24/6
S11356*■	8A19/LED/927/SW/120V	8	A19	E26	120	Soft White	2700K	800	90	4 3/8	15K	045923113567	24/6
S11355*■	8A19/LED/930/CL/120V	8	A19	E26	120	Clear	3000K	800	90	4 3/8	15K	045923113550	24/6

■ Also T24 compliant. † Silver crown are 180° beam angle.

**See warranty for details.

LED filament lamps 75 & 100 Watt replacements



S9845, S9846



S11500, S11501,
S11502



S11505, S11506,
S11507



S11510, S11511,
S11512

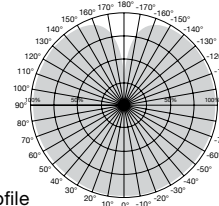

Beam Profile

Beam Angle: 360°



LED Filament Lamps - Single Pks

Item Number	Lamp Description	W	Bulb Type	Base	V	Finish	CCT	Lm	CRI	M.O.L. (Inches)	Life/Hrs.	UPC	Pack
75 Watt Replacement													
S9845 [†]	9A19/CL/LED/E26/27K/120V	9	A19	E26	120	Clear	2700K	1100	80	4 ½	15K	045923098451	24
S9846 [†]	9A19/CL/LED/E26/30K/120V	9	A19	E26	120	Clear	3000K	1100	80	4 ½	15K	045923098468	24
S11500 [♦]	9A19/FR/LED/E26/827/120V	9	A19	E26	120	Frost	2700K	1100	80	4	15K	045923115004	24
S11501 [♦]	9A19/FR/LED/E26/830/120V	9	A19	E26	120	Frost	3000K	1100	80	4	15K	045923115011	24
S11502 [♦]	9A19/FR/LED/E26/840/120V	9	A19	E26	120	Frost	4000K	1100	80	4	15K	045923115028	24
90 CRI—CEC/T20													
S11357 [■]	11A19/LED/927/CL/120V	11	A19	E26	120	Clear	2700K	1100	90	5 1/16	15K	045923113574	24
S11359 [■]	11A19/LED/927/SW/120V	11	A19	E26	120	Soft White	2700K	1100	90	5 1/16	15K	045923113598	24
S11358 [■]	11A19/LED/930/CL/120V	11	A19	E26	120	Clear	3000K	1100	90	5 1/16	15K	045923113581	24
100 Watt Replacement													
S11505 [♦]	13A19/FR/LED/E26/827/120V	13	A19	E26	120	Frost	2700K	1500	80	4 3/8	15K	045923115059	24
S11506 [♦]	13A19/FR/LED/E26/830/120V	13	A19	E26	120	Frost	3000K	1500	80	4 3/8	15K	045923115066	24
S11507 [♦]	13A19/FR/LED/E26/840/120V	13	A19	E26	120	Frost	4000K	1500	80	4 3/8	15K	045923115073	24
S11510 [♦]	12A19/CL/LED/E26/827/120V	12	A19	E26	120	Clear	2700K	1500	80	4 3/8	15K	045923115103	24
S11511 [♦]	12A19/CL/LED/E26/830/120V	12	A19	E26	120	Clear	3000K	1500	80	4 3/8	15K	045923115110	24
S11512 [♦]	12A19/CL/LED/E26/840/120V	12	A19	E26	120	Clear	4000K	1500	80	4 3/8	15K	045923115127	24
90 CRI—CEC/T20													
S11360 [■]	14A21/LED/927/CL/120V	14	A21	E26	120	Clear	2700K	1600	90	4 ½	15K	045923113604	24
S11362 [■]	14A21/LED/927/SW/120V	14	A21	E26	120	Soft White	2700K	1600	90	4 ½	15K	045923113628	24
S11361 [■]	14A21/LED/930/CL/120V	14	A21	E26	120	Clear	3000K	1600	90	4 ½	15K	045923113611	24

■ Also T24 compliant. JA8-2019

See warranty for details.

LED filament lamps Multi-Packs



S21712, S21713,
S21734



S21714



S11503, S11504



S11508, S11509



S11513, S11514

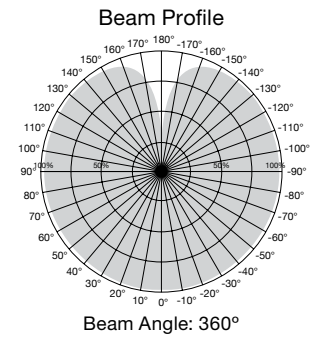

LED A19 Filament Lamp - Multi-Pks



Item Number	Lamp Description	W	Bulb Type	Base	V	Finish	CCT	Lm	CRI	M.O.L. (Inches)	Life/ Hrs.	UPC	Pack
40 Watt Replacement													
S21712 ^{††}	5A19/CL/LED/E26/27K/120V/4PK	5	A19	E26	120	Clear	2700K	450	80	4 1/8	15K	045923217128	12/4Pks
60 Watt Replacement													
S21713 ^{††}	7.5A19/CL/LED/E26/27K/120V/4PK	7.5	A19	E26	120	Clear	2700K	800	80	4 1/8	15K	045923217135	12/4Pks
S21714 ^{††}	7.5A19/SW/LED/E26/27K/120V/4PK	7.5	A19	E26	120	Soft White	2700K	800	80	4 1/8	15K	045923217142	12/4Pks
S21734 [*]	7.5A19/CL/LED/E26/3K/120V/4PK	7.5	A19	E26	120	Clear	3000K	800	80	4 1/8	15K	045923217340	12/4Pks
75 Watt Replacement													
S11503 [♦]	9A19/FR/LED/E26/827/120V/4PK	9	A19	E26	120	Frost	2700K	1100	80	4	15K	045923115035	12/4Pks
S11504 [♦]	9A19/FR/LED/E26/830/120V/4PK	9	A19	E26	120	Frost	3000K	1100	80	4	15K	045923115042	12/4Pks
100 Watt Replacement													
S11513 [♦]	12A19/CL/LED/E26/827/120V/4PK	12	A19	E26	120	Clear	2700K	1500	80	4 3/8	15K	045923115134	12/4Pks
S11514 [♦]	12A19/CL/LED/E26/830/120V/4PK	12	A19	E26	120	Clear	3000K	1500	80	4 3/8	15K	045923115141	12/4Pks
S11508 [♦]	13A19/FR/LED/E26/827/120V/4PK	13	A19	E26	120	Frost	2700K	1500	80	4 3/8	15K	045923115080	12/4Pks
S11509 [♦]	13A19/FR/LED/E26/830/120V/4PK	13	A19	E26	120	Frost	3000K	1500	80	4 3/8	15K	045923115097	12/4Pks

**See warranty for details.

LED filament lamps Globes - G16½

LED with a traditional incandescent look and feel

Omni-directional light source

Dimmable

Damp location

Approved for totally enclosed fixtures***

c-UL-us listed

CEC T20/T24 Available

ENERGY STAR certified*

3 Year warranty



S12105
G16



S12102, S12103,
S12104
G16



S12101
G16



S9870, S29871,
S29988, S8553
G16 1/2

LED Globe Filament Lamps - G16½



Item Number	Lamp Description	W	Bulb Type	Base	V	Finish	CCT	Lm	CRI	M.O.L. (Inches)	Life/ Hrs.	UPC	Pack
S9870	2.5G16/LED/CL/27K/120V/E12	2.5	G16 1/2	E12	120	Clear	2700K	200	80	3 3/16	15K	045923098703	24/6
S29871*	4G16/LED/CL/27K/120V/E12	4	G16 1/2	E12	120	Clear	2700K	350	80	3 3/16	15K	045923298714	24/6
S29988*	5.5G16/LED/CL/27K/120V/E12	5.5	G16 1/2	E12	120	Clear	2700K	500	80	3 1/8	15K	045923099885	24/6
S12100	4.5G16/LED/CL/3K/120V/E12	4.5	G16 1/2	E12	120	Clear	3000K	500	80	3 1/8	15K	045923121005	24/6
S12101	5.5G16/LED/SW/3K/120V/E12	5.5	G16 1/2	E12	120	Soft White	3000K	500	80	3 1/8	15K	045923121012	24/6
S12102	5.5G16/LED/CL/27K/120V/E26	5.5	G16 1/2	E26	120	Clear	2700K	500	80	3 1/8	15K	045923121029	24/6
S12103	5.5G16/LED/CL/3K/120V/E26	5.5	G16 1/2	E26	120	Clear	3000K	500	80	3 1/8	15K	045923121036	24/6
S12104	5.5G16/LED/CL/4K/120V/E26	5.5	G16 1/2	E26	120	Clear	4000K	500	80	3 1/8	15K	045923121043	24/6
S12105	5.5G16/LED/SW/3K/120V/E26	5.5	G16 1/2	E26	120	Soft White	3000K	500	80	3 1/8	15K	045923121050	24/6
90 CRI—CEC/T20													
S8553*	4G16/LED/CL/927/120V/E12	4	G16 1/2	E12	120	Clear	2700K	350	90	3 3/16	15K	045923085536	24/6
S11364*	4.5G16/LED/SW/927/120V/E12	4.5	G16 1/2	E12	120	Soft White	2700K	360	90	3 1/4	15K	045923113642	24/6
S11363*	4.5G16/LED/CL/930/120V/E12	4.5	G16 1/2	E12	120	Clear	3000K	360	90	3 1/4	15K	045923113635	24/6

Product sheet SA1980

**See warranty for details.

LED filament lamps Globes - G25



S21737, S21739
G25 Clear



S29563, S9893, S8849,
S12106, S9564, S12110
Clear G25



S9827, S12107, S12108,
S12109, S21738, S21740
White G25



S9828
G25



LED Globe Filament Lamps - G25

Item Number	Lamp Description	W	Bulb Type	Base	V	Finish	CCT	Lm	CRI	M.O.L. (Inches)	Life/Hrs.	UPC	Pack
40 Watt Replacement													
S12107	4G25/SW/LED/E26/3K/120V	4	G25	E26	120	Soft White	3000K	350	80	4 ½	15K	045923121074	24/6
S29563*	4.5G25/CL/LED/E26/27K/120V	4.5	G25	E26	120	Clear	2700K	450	80	4 ¾	20K	045923295638	24/6
S9893*	4.5G25/CL/LED/E26/30K/120V	4.5	G25	E26	120	Clear	3000K	450	80	4 ¾	15K	045923098932	24/6
S8849*	4.5G25/CL/LED/E26/40K/120V	4.5	G25	E26	120	Clear	4000K	450	80	4 ¾	15K	045923088490	24/6
S12106	4.5G25/CL/LED/E26/5K/120V	4.5	G25	E26	120	Clear	5000K	450	80	4 ½	15K	045923121067	24/6
S9827*	4.5G25/SW/LED/E26/27K/120V	4.5	G25	E26	120	Soft White	2700K	430	80	4 ¾	15K	045923098277	24/6
S9828†	4.5G25/SLV/LED/E26/27K/120V	4.5	G25	E26	120	Silver Crown	2700K	430	80	4 ¾	15K	045923098284	24/6
60 Watt Replacement													
S9564*	6.5G25/CL/LED/E26/27K/120V	6.5	G25	E26	120	Clear	2700K	810	80	4 ¾	15K	045923095641	24/6
S12110	6.5G25/CL/LED/E26/3K/120V	6.5	G25	E26	120	Clear	3000K	810	80	4 ½	15K	045923121104	24/6
S12108	6.5G25/SW/LED/E26/27K/120V	6.5	G25	E26	120	Soft White	2700K	650	80	4 ½	15K	045923121081	24/6
S12109	6.5G25/SW/LED/E26/3K/120V	6.5	G25	E26	120	Soft White	3000K	650	80	4 ½	15K	045923121098	24/6
Multi-Pks													
S21737*	4.5G25/LED/CL/27K/120V/2Pk	4.5	G25	E26	120	Clear	2700K	350	80	4 ½	15K	045923217371	12/2Pks
S21738*	4.5G25/LED/WH/27K/120V/2Pk	4.5	G25	E26	120	White	2700K	350	80	4 ½	15K	045923217388	12/2Pks
S21739*	5.5G25/LED/CL/27K/120V/2Pk	5.5	G25	E26	120	Clear	2700K	500	80	4 ½	15K	045923217395	12/2Pks
S21740*	5.5G25/LED/WH/27K/120V/2Pk	5.5	G25	E26	120	White	2700K	500	80	4 ½	15K	045923217401	12/2Pks
90 CRI—CEC/T20													
S29878*■	5.5G25/LED/927/CL/120V	5.5	G25	E26	120	Clear	2700K	500	90	4	15K	045923298783	24/6
S11365*■	5.5G25/LED/930/CL/120V	5.5	G25	E26	120	Clear	3000K	500	90	4	15K	045923113659	24/6
S11366*■	5.5G25/LED/930/SW/120V	5.5	G25	E26	120	Soft White	3000K	500	90	4	15K	045923113666	24/6

† Silver crown are 180° beam angle. ■ Also T24 compliant.

**See warranty for details.

LED filament lamps

Globes - G40

- LED with a traditional incandescent look and feel
- Omni-directional light source
- Dimmable
- Damp location
- Approved for totally enclosed fixtures***
- c-UL-us listed
- CEC T20/T24 Available
- ENERGY STAR certified*
- 3 Year warranty



S12112, S12113
G40



S9565, S9566,
S12111
G40

LED Globe Filament Lamps - G40



Item Number	Lamp Description	W	Bulb Type	Base	V	Finish	CCT	Lm	CRI	M.O.L. (Inches)	Life/ Hrs.	UPC	Pack
40 Watt Replacement													
S9565	4.5G40/CL/LED/E26/27K/120V	4.5	G40	E26	120	Clear	2700K	450	80	6 ½	15K	045923095658	12
60 Watt Replacement													
S9566	6.5G40/CL/LED/E26/27K/120V	6.5	G40	E26	120	Clear	2700K	800	80	6 ½	15K	045923095665	12
S12111	6.5G40/CL/LED/E26/3K/120V	6.5	G40	E26	120	Clear	3000K	810	80	6 ½	15K	045923121111	12
S12112	6.5G40/SW/LED/E26/27K/120V	6.5	G40	E26	120	Soft White	2700K	650	80	6 ½	15K	045923121128	12
S12113	6.5G40/SW/LED/E26/3K/120V	6.5	G40	E26	120	Soft White	3000K	650	80	6 ½	15K	045923121135	12

90 CRI – CEC/T20

S11367■	8G40/LED/930/CL/120V	8	G40	E26	120	Clear	3000K	800	90	6 7/8	15K	045923113673	12
S11368■	8G40/LED/930/SW/120V	8	G40	E26	120	Soft White	3000K	800	90	6 7/8	15K	045923113680	12

■ Also T24 compliant. JA8-2019

Product sheet SA1980

**See warranty for details.

LED filament lamps

Decorative - Candelabra base/torpedo



S29877, S29866, S29920,
S29922, S29890, S8839,
S9960, S9961, S21708,
S21729
C11/B11



S9868
C11



S21708,
S21729
B11



LED Decorative Filament Lamps - Candelabra Base - Torpedo Shape



Item Number	Lamp Description	W	Bulb Type	Base	V	Finish	CCT	Lm	CRI	M.O.L. (Inches)	Life/Hrs.	UPC	Pack
25 Watt Replacement													
S29920*	2.5W CTC/LED/CL/27K/120V	2.5	C11	E12	120	Clear	2700K	200	80	3 7/8	15K	045923299209	24/6
40 Watt Replacement													
S9868	3.5CTF/LED/FR/27K/120V	3.5	C11	E12	120	Frosted	2700K	350	80	4 5/16	15K	045923098680	24/6
S29922*	4W CTC/LED/27K/CL/120V	4	C11	E12	120	Clear	2700K	350	80	3 7/8	15K	045923299223	24/6
S29890*	4W CTC/LED/30K/CL/120V	4	C11	E12	120	Clear	3000K	350	80	3 7/8	15K	045923298905	24/6
S8839	4W CTC/LED/40K/CL/120V	4	C11	E12	120	Clear	4000K	350	80	3 7/8	15K	045923088391	24/6
S29866*	4W CTC/LED/50K/CL/120V	4	C11	E12	120	Clear	5000K	350	80	4 5/16	15K	045923298660	24/6
60 Watt Replacement													
S9960*	5.5W CTC/LED/27K/CL/120V	5.5	C11	E12	120	Clear	2700K	500	80	3 7/8	15K	045923099601	24/6
S9961*	5.5W CTC/LED/30K/CL/120V	5.5	C11	E12	120	Clear	3000K	500	80	3 7/8	15K	045923099618	24/6
S9964*	5.5W ETC/LED/27K/CL/120V	5.5	C11	E26	120	Clear	2700K	500	80	3 1/2	15K	045923099649	24/6
Multi-Pks													
S21708*	4.5W CTC/LED/27K/CL/120V/3Pk	4.5	B11	E12	120	Clear	2700K	350	80	3 7/8	15K	045923217081	12/3Pks
S21729*	4.5W CTC/LED/3K/CL/120V/3Pk	4.5	B11	E12	120	Clear	3000K	350	80	3 7/8	15K	045923217296	12/3Pks
90 CRI—CEC/T20 - 40 Watt Replacement													
S29877*■	4.5WCTC/LED/927/120/E12	4.5	B11	E12	120	Clear	2700K	350	90	3 3/4	15K	045923298776	24/6
S11369*	4.5CTF/LED/927/120V/E12	4.5	B11	E12	120	Frosted	2700K	360	90	3 3/4	15K	045923113697	24/6
S11370*	4.5CTC/LED/930/120V/E12	4.5	B11	E12	120	Clear	3000K	360	90	3 3/4	15K	045923113703	24/6
90 CRI—CEC/T20 - 60 Watt Replacement													
S11371*	5.5CTC/LED/927/120V/E12	5.5	B11	E12	120	Clear	2700K	500	90	3 3/4	15K	045923113710	24/6
S11373*	5.5CTF/LED/927/120V/E12	5.5	B11	E12	120	Frosted	2700K	500	90	3 3/4	15K	045923113734	24/6
S11372*	5.5CTC/LED/930/120V/E12	5.5	B11	E12	120	Clear	3000K	500	90	3 3/4	15K	045923113727	24/6

■ Also T24 compliant. JA8-2019

Product sheet SA1980

**See warranty for details.

LED filament lamps Decorative - Medium base/torpedo

LED with a traditional incandescent look and feel

Omni-directional light source

Dimmable

Damp location

Approved for totally enclosed fixtures***

c-UL-us listed

CEC T20/T24 Available

ENERGY STAR certified*

3 Year warranty



C11/B11



LED Decorative Filament Lamps - Medium Base - Torpedo Shape



Item Number	Lamp Description	W	Bulb Type	Base	V	Finish	CCT	Lm	CRI	M.O.L. (Inches)	Life/ Hrs.	UPC	Pack
25 Watt Replacement													
S9567*	2.5W ETC/LED/27K/120V	2.5	C11	E26	120	Clear	2700K	250	80	3 1/2	25K	045923095672	24/6
40 Watt Replacement													
S9569*	4.5W ETC/LED/27K/120V	4.5	C11	E26	120	Clear	2700K	450	80	3 1/2	15K	045923095696	24/6
60 Watt Replacement													
S9964*	5.5W ETC/LED/27K/CL/120V	5.5	C11	E26	120	Clear	2700K	500	80	3 1/2	15K	045923099649	24/6
Multi-Pks													
S21709	4.5W ETC/LED/27K/CL/120V/3Pk	4.5	B11	E26	120	Clear	2700K	350	80	3 3/8	15K	045923217098	12/3Pks
90 CRI - CEC/T20													
S8551*	4WETC/LED/927/CL/120V	4	B11	E26	120	Clear	2700K	350	90	3 1/2	15K	045923085512	24/6
S11375*■	4.3ETF/LED/927/120V/E26	4.3	B11	E26	120	Frosted	2700K	350	90	3 3/4	15K	045923113758	24/6
S11374*■	4.3ETC/LED/930/120V/E26	4.3	B11	E26	120	Clear	3000K	350	90	3 3/4	15K	045923113741	24/6

■ Also T24 compliant. JA8-2019

Product sheet SA1980

**See warranty for details.

LED filament lamps Decorative - Flame tip



S29867, S29921, S29923, S29891
S8840, S9962, S9963, S8552
CA11

S9869
CA11

LED Decorative Filament Lamps - Candelabra Base - Flame Tip



Item Number	Lamp Description	W	Bulb Type	Base	V	Finish	CCT	Lm	CRI	M.O.L. (Inches)	Life/ Hrs.	UPC	Pack
25 Watt Replacement													
S29921*	2.5W CFC/LED/CL/27K/120V	2.5	CA11	E12	120	Clear	2700K	200	80	4 1/16	15K	045923299216	24/6
40 Watt Replacement													
S9869	3.5CFF/LED/FR/27K/120V	3.5	CA11	E12	120	Frosted	2700K	350	80	5	15K	045923098697	24/6
S29923*	4W CFC/LED/27K/CL/120V	4	CA11	E12	120	Clear	2700K	350	80	4 1/16	15K	045923299230	24/6
S29891*	4W CFC/LED/30K/CL/120V	4	CA11	E12	120	Clear	3000K	350	80	4 1/16	15K	045923298912	24/6
S8840*	4W CFC/LED/40K/CL/120V	4	CA11	E12	120	Clear	4000K	350	80	4 1/16	15K	045923088407	24/6
S29867*	4W CFC/LED/50K/CL/120V	4	CA11	E12	120	Clear	5000K	350	80	5	15K	045923298677	24/6
60 Watt Replacement													
S9962*	5.5W CFC/LED/27K/CL/120V	5.5	CA11	E12	120	Clear	2700K	500	80	4 1/16	15K	045923099625	24/6
S9963*	5.5W CFC/LED/30K/CL/120V	5.5	CA11	E12	120	Clear	3000K	500	80	4 1/16	15K	045923099632	24/6
90 CRI—CEC/T20													
S8552*	4.5CFC/LED/927/120/E12	4.5	CA11	E12	120	Clear	2700K	350	90	4 3/4	15K	045923085529	24/6
S11376*	4.5CFC/LED/930/120V/E12	4.5	CA11	E12	120	Clear	3000K	360	90	3 3/4	15K	045923113765	24/6
S11377*	4.5CFF/LED/930/120V/E12	4.5	CA11	E12	120	Frosted	3000K	360	90	3 3/4	15K	045923113772	24/6

Product sheet SA1980



S9571, S9965
CA11

LED Decorative Filament Lamps - Medium Base - Flame Tip



Item Number	Lamp Description	W	Bulb Type	Base	V	Finish	CCT	Lm	CRI	M.O.L. (Inches)	Life/ Hrs.	UPC	Pack
25 Watt Replacement													
S9571	2.5W EFC/LED/27K/120V	2.5	CA11	E26	120	Clear	2700K	250	80	4 3/16	15K	045923095719	24/6
60 Watt Replacement													
S9965*	5.5W EFC/LED/27K/CL/120V	5.5	CA11	E26	120	Clear	2700K	500	80	4 3/16	15K	045923099656	24/6

**See warranty for details.

LED filament lamps

- LED with a traditional incandescent look and feel
- Omni-directional light source
- Dimmable
- Damp location
- Approved for totally enclosed fixtures***
- c-UL-us listed
- CEC T20/T24 Available
- ENERGY STAR certified*
- 3 Year warranty

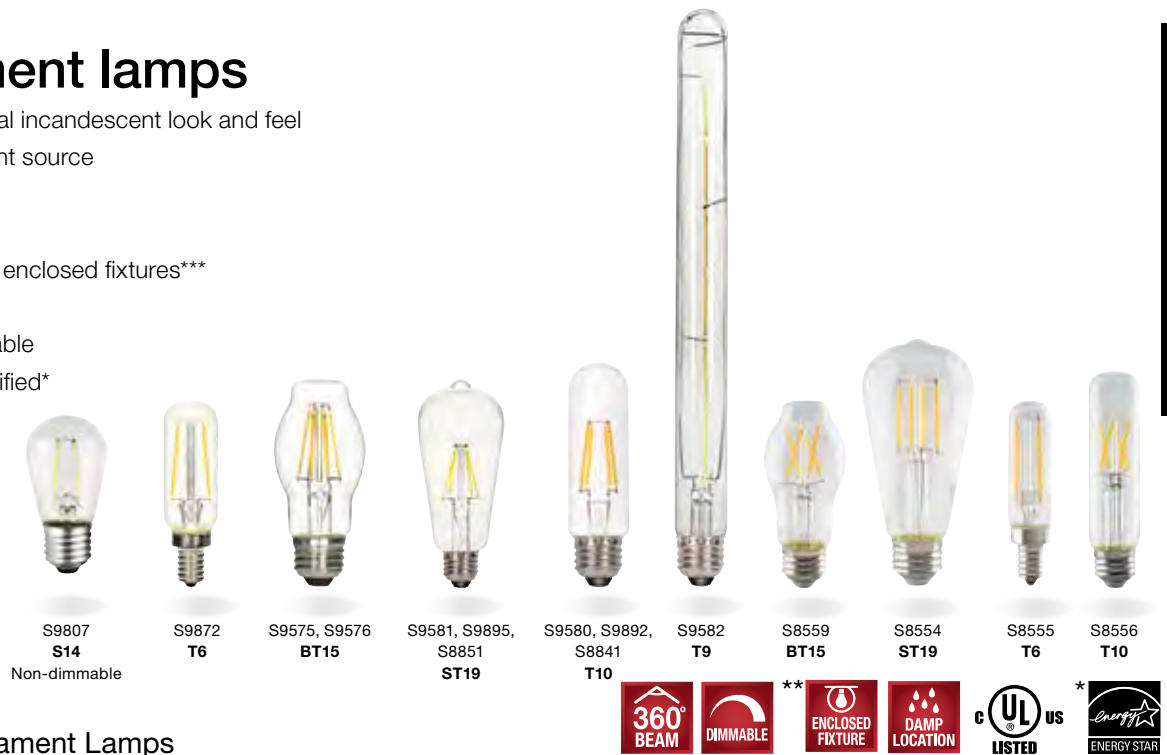

LED Specialty Filament Lamps

Item Number	Lamp Description	W	Bulb Type	Base	V	Finish	CCT	Lm	CRI	M.O.L. (Inches)	Life/Hrs.	UPC	Pack
S9807†	1WS14/LED/CL/27K/120V/ND	1	S14	E26	120	Clear	2700K	100	80	1 3/4	15K	045923098079	24/12
S9872	2.5T6/LED/CL/27K/E12/120V	2.5	T6	E12	120	Clear	2700K	200	80	3 3/16	15K	045923098727	24/6
S9575	4.5BT15/CL/LED/E26/27K/120V	4.5	BT15	E26	120	Clear	2700K	450	80	4 1/8	15K	045923095757	24/6
S9576	6.5BT15/CL/LED/E26/27K/120V	6.5	BT15	E26	120	Clear	2700K	800	80	4 1/8	15K	045923095764	24/6
S9581	6.5ST19/CL/LED/E26/27K/120V	6.5	ST19	E26	120	Clear	2700K	810	80	5 1/2	15K	045923095818	24/6
S9895	6.5ST19/CL/LED/E26/30K/120V	6.5	ST19	E26	120	Clear	3000K	810	80	5 1/2	15K	045923098956	24/6
S8851	6.5ST19/CL/LED/E26/40K/120V	6.5	ST19	E26	120	Clear	4000K	810	80	5 1/2	15K	045923088513	24/6
S9580	4.5T10/LED/E26/27K/120V	4.5	T10	E26	120	Clear	2700K	430	80	5	15K	045923095801	24/6
S9892	4.5T10/LED/E26/30K/120V	4.5	T10	E26	120	Clear	3000K	430	80	5	15K	045923098925	24/6
S8841	4.5T10/LED/E26/40K/120V	4.5	T10	E26	120	Clear	4000K	450	80	5	15K	045923088414	24/6
S9582	6.5T9/CL/LED/E26/27K/120V	6.5	T9	E26	120	Clear	2700K	800	80	12	15K	045923095825	24/6
BT15 90 CRI—CEC/T20													
S8559■	5.5BT15/LED/927/CL/120V	5.5	BT15	E26	120	Clear	2700K	500	90	3 5/8	15K	045923085598	24/6
S11378■	8BT15/LED/927/CL/120V	8	BT15	E26	120	Clear	2700K	800	90	4 1/4	15K	045923113789	24/6
S11379■	8BT15/LED/927/SW/120V	8	BT15	E26	120	Soft White	2700K	800	90	4 1/4	15K	045923113796	24/6
ST19 90 CRI—CEC/T20													
S8554*	5.5ST19/LED/927/CL/120V	5.5	ST19	E26	120	Clear	2700K	500	90	5 1/2	15K	045923085543	24/6
S11382■	8ST19/LED/930/CL/120V	8	ST19	E26	120	Clear	3000K	800	90	4 7/8	15K	045923113826	24/6
Tubular 90 CRI—CEC/T20													
S8555*	2.5T6/LED/927/CL/E12	2.5	T6	E12	120	Clear	2700K	180	90	3 3/16	15K	045923085550	24/6
S8556	4T10/LED/E26/27K/120V	4	T10	E26	120	Clear	2700K	350	90	5	15K	045923085567	24/6
S11381■	4.3T10/LED/930/CL/120V	4.3	T10	E26	120	Clear	3000K	350	90	5 3/8	15K	045923113819	24/6
S11380■	8T9/LED/927/CL/120V	8	T9	E26	120	Clear	2700K	800	90	4 15/16	15K	045923113802	24/6

■ Also T24 compliant. JA8-2019. †Non-Dimmable

Product sheet SA1980

**See warranty for details.

LED filament lamps

Vintage style

- LED with a traditional incandescent look and feel
- Omni-directional light source
- Dimmable
- Damp location
- Approved for totally enclosed fixtures***
- c-UL-us listed
- CEC T20/T24 Available
- ENERGY STAR certified*
- 3 Year warranty

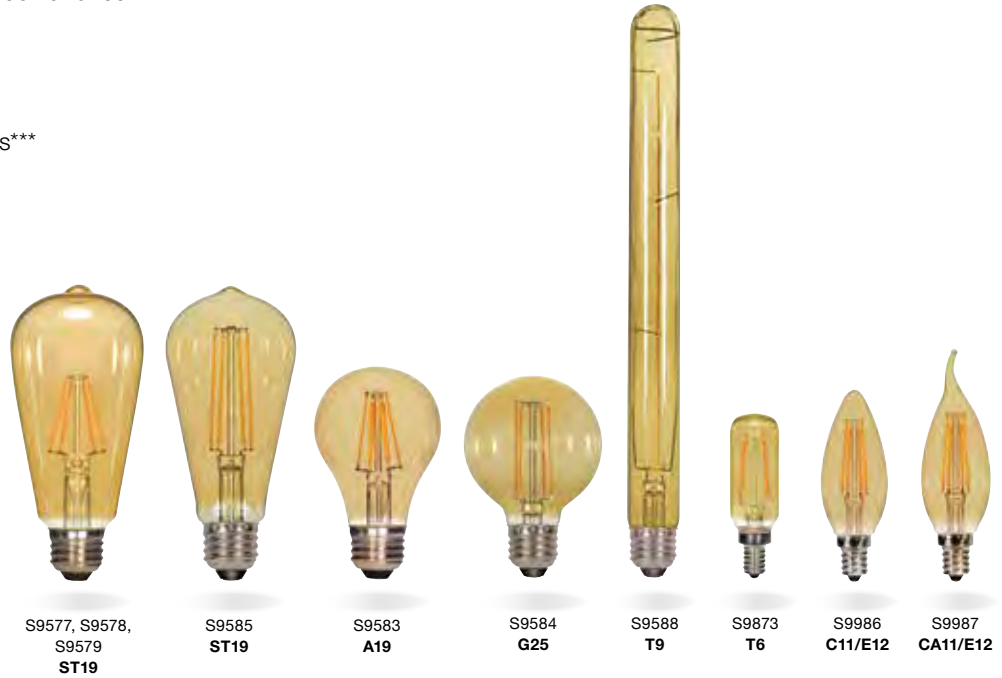

S9577, S9578, S9579 **ST19** S9585 **ST19** S9583 **A19** S9584 **G25** S9588 **T9** S9873 **T6** S9986 **C11/E12** S9987 **CA11/E12**

Vintage Style LED Filament Lamps



Item Number	Lamp Description	W	Bulb Type	Base	V	Finish	CCT	Lm	CRI	M.O.L. (Inches)	Life/ Hrs.	UPC	Pack
ST19													
S9577	2.5ST19/AMB/LED/E26/2K/120V	2.5	ST19	E26	120	Amber	2000K	220	80	5 3/8	15K	045923095771	24/6
S9578	4.5ST19/AMB/LED/E26/2K/120V	4.5	ST19	E26	120	Amber	2000K	380	80	5 3/8	15K	045923095788	24/6
S9579	6.5ST19/AMB/LED/E26/2K/120V	6.5	ST19	E26	120	Amber	2000K	650	80	5 3/8	15K	045923095795	24/6
S9585	4.5ST19LONG/AMB/LED/E26/2K/120V	4.5	ST19	E26	120	Amber	2000K	380	80	5 1/2	15K	045923095856	24/6
A19													
S9583	4.5A19/AMB/LED/E26/2K/120V	4.5	A19	E26	120	Amber	2000K	380	80	4 1/8	15K	045923095832	24/6
G25													
S9584	4.5G25/AMB/LED/E26/2K/120V	4.5	G25	E26	120	Amber	2000K	380	80	4 3/8	15K	045923095849	24/6
T9													
S9588	6.5T9/AMB/LED/E26/2K/120V	6.5	T9	E26	120	Amber	2000K	620	80	12	15K	045923095887	24/6
T6													
S9873	2.5T6/AMB/LED/E12/2K/120V	2.5	T6	E12	120	Amber	2000K	150	80	3 3/8	15K	045923098734	24/6
C11													
S9986	3.5CTA/AMB/LED/2K/120V	3.5	C11	E12	120	Amber	2000K	300	80	4 3/8	15K	045923099861	24/6
CA11													
S9987	3.5CFA/AMB/LED/2K/120V	3.5	CA11	E12	120	Amber	2000K	300	80	5	15K	045923099878	24/6

Product sheets SA1980

**See warranty for details.

LED filament lamps Vintage style - spiral



Vintage Style LED Spiral Filament Lamps



Item Number	Lamp Description	W	Bulb Type	Base	V	Finish	CCT	Lm	CRI	M.O.L. (Inches)	Life/Hrs.	UPC	Pack
ST19													
S9967	4.5ST19/SPIRAL/LED/AMB/120V	4.5	ST19	E26	120	Amber	2000K	240	80	5 ¼	15K	045923099670	24/6
A19													
S9966	4.5A19/SPIRAL/LED/AMB/120V	4.5	A19	E26	120	Amber	2000K	220	80	4 ⅙	15K	045923099663	24/6
G30													
S9968	4.5G30/SPIRAL/LED/AMB/120V	4.5	G30	E26	120	Amber	2000K	240	80	5 ⅙	15K	045923099687	24/6
G40													
S9969	4.5G40/SPIRAL/LED/AMB/120V	4.5	G40	E26	120	Amber	2000K	240	80	6 ⅝	15K	045923099694	24/6
T9													
S9971	4.5T9/SPIRAL/LED/AMB/120V	4.5	T9	E26	120	Amber	2000K	240	80	7 ⅜	15K	045923099717	24/6
B10													
S9970	2.3ETC/SPIRAL/LED/AMB/120V	2.3	B10	E26	120	Amber	2000K	90	80	3 ½	15K	045923099700	24/6

Product sheets SA1980

**See warranty for details.

Vintage style LED spiral filament lamps in HID envelopes

Classic, warm glow
and ambiance on an
impressive scale.

- Restaurants
- Hotels
- Retail
- Restoration projects
- Themed venues
- Uses only 4 Watts
- Impressive size and presence
- Perfect for pendant fixtures and hanging sockets
- Approved for totally enclosed fixtures**
- Unique LED spiral filament
- Omni-directional light source
- Dimmable
- Wet location
- 2150K
- T24, BT38, BT56 and PS52 shapes
- E26 base
- Long life—25,000 hours
- 3 Year warranty



Spiral Filament LED Lamps in HID Envelopes



Item Number	Lamp Description	W	V	Bulb Type	Base Type	CCT	Lm	Finish	M.O.L. (Inches)	Life/ Hrs.	UPC	Pack/ Master
S22430	4T24/LED/CLEAR/E26/VINTAGE/120V	4	120	T24	E26	2150K	200	Clear	13	25K	045923224300	12
S22431	4BT38/LED/CLEAR/E26/VINTAGE/120V	4	120	BT38	E26	2150K	200	Clear	16 1/2	25K	045923224317	12
S22432	4BT56/LED/CLEAR/E26/VINTAGE/120V	4	120	BT56	E26	2150K	200	Clear	13 13/16	25K	045923224324	6
S22433	4PS52/LED/CLEAR/E26/VINTAGE/120V	4	120	PS52	E26	2150K	200	Clear	11 13/16	25K	045923224331	6

Product sheet SA1980

**See warranty for details.

LED filament lamps - Carded



A15

 A19
Clear

 A19
White

B11 / C11

CA10 / CA11

LED Filament Lamps



Item Number	Lamp Description	W	Bulb Type	Base	V	Finish	CCT	Lm	Life/ Hrs.	UPC	Pack
A15											
S8615*	4.5A15/CL/LED/E26/27K/ES/120V/1CD	4.5	A15	E26	120	Clear	2700K	450	15K	045923086151	12/1 cd
S21710*	5.5A15/LED/2700K/E12/120V/2CD	5.5	A15	E12	120	Clear	2700K	450	15K	045923217104	12/2 cd
S21733*	5A15/LED/WH/27K/E26/120V/2CD	5	A15	E26	120	White	2700K	450	15K	045923217333	12/2 cd
S21711*	5.5A15/LED/2700K/E26/120V/2CD	5.5	A15	E26	120	Clear	2700K	450	15K	045923217111	12/2 cd
A19											
S8616*	7A19/CL/LED/E26/27K/ES/120V/1CD	7	A19	E26	120	Clear	2700K	800	15K	045923086168	12/1 cd
Decorative - Torpedo Shape - Candelabra Base											
S21700*	2.5W CTC/LED/27K/CL/120V/2CD	2.5	B11	E12	120	Clear	2700K	180	15K	045923217005	12/2 cd
S28613*	4WCTC/LED/27K/CL/120V/1CD	4	C11	E12	120	Clear	2700K	350	15K	045923286131	12/1 cd
S21702*	4.5W CTC/LED/27K/CL/120V/2CD	4.5	B11	E12	120	Clear	2700K	350	15K	045923217029	12/2 cd
S21704*	4.5W CTF/LED/27K/FR/120V/2CD	4.5	B11	E12	120	Frosted	2700K	330	15K	045923217043	12/2 cd
S21728*	4.5W CTC/LED/5K/CL/120V/2CD	4.5	B11	E12	120	Clear	5000K	350	15K	045923217289	12/2 cd
S21706	5.5W CTC/LED/27K/CL/120V/2CD	5.5	B11	E12	120	Clear	2700K	500	15K	045923217067	12/2 cd
Decorative - Torpedo Shape - Medium Base											
S21701*	2.5W ETC/LED/27K/CL/120V/2CD	2.5	B11	E26	120	Clear	2700K	180	15K	045923217012	12/2 cd
S21703*	4.5W ETC/LED/27K/CL/120V/2CD	4.5	B11	E26	120	Clear	2700K	350	15K	045923217036	12/2 cd
S8609*	4.5WETC/LED/27K/120V/1CD	4.5	C11	E26	120	Clear	2700K	450	15K	045923086090	12/1 cd
S21705*	4.5W ETF/LED/27K/FR/120V/2CD	4.5	B11	E26	120	Frosted	2700K	330	15K	045923217050	12/2 cd
S21730*	4.5W ETC/LED/5K/CL/120V/2CD	4.5	B11	E26	120	Clear	5000K	350	15K	045923217302	12/2 cd
S21707*	5.5W ETC/LED/27K/CL/120V/2CD	5.5	B11	E26	120	Clear	2700K	500	15K	045923217074	12/2 cd

Product sheets SA2607

**See warranty for details.

LED filament lamps - Carded



G16 1/2



ST19



LED Filament Lamps



Item Number	Lamp Description	W	Bulb Type	Base	V	Finish	CCT	Lm	Life/ Hrs.	UPC	Pack
Decorative - Flame Tip - Candelabra Base											
S21720*	2.5W CFC/LED/27K/CL/120V/2CD	2.5	CA10	E12	120	Clear	2700K	180	15K	045923217203	12/2 cd
S28614*	4WCFC/LED/27K/CL/120V /1CD	4	CA11	E12	120	Clear	2700K	350	15K	045923286148	12/1 cd
S21721*	4.5W CFC/LED/27K/CL/120V/2CD	4.5	CA10	E12	120	Clear	2700K	350	15K	045923217210	12/2 cd
S21732*	4.5W CFF/LED/27K/FR/120V/2CD	4.5	CA10	E12	120	Frost	2700K	350	15K	045923217326	12/2 cd
S21722*	4.5W CFC/LED/5K/CL/120V/2CD	4.5	CA10	E12	120	Clear	5000K	350	15K	045923217227	12/2 cd
S21723*	5.5W CFC/LED/27K/CL/120V/2CD	5.5	CA10	E12	120	Clear	2700K	500	15K	045923217234	12/2 cd
Decorative - Flame Tip - Medium Base											
S21724*	2.5W EFC/LED/27K/CL/120V/2CD	2.5	CA10	E26	120	Clear	2700K	180	15K	045923217241	12/2 cd
S21725*	4.5W EFC/LED/27K/CL/120V/2CD	4.5	CA10	E26	120	Clear	2700K	350	15K	045923217258	12/2 cd
S21731*	4.5W EFF/LED/27K/FR/120V/2CD	4.5	CA10	E26	120	Frost	2700K	350	15K	045923217319	12/2 cd
S21726*	4.5W EFC/LED/5K/CL/120V/2CD	4.5	CA10	E26	120	Clear	5000K	350	15K	045923217265	12/2 cd
S8610*	4.5WEFC/LED/27K/120V/1CD	4.5	CA11	E26	120	Clear	2700K	450	15K	045923086106	12/1 cd
S21727*	5.5W EFC/LED/27K/CL/120V/2CD	5.5	CA10	E26	120	Clear	2700K	500	15K	045923217272	12/2 cd
G16											
S21735*	4.5G16/LED/CL/27K/E12/120V/2CD	4.5	G16 1/2	E12	120	Clear	2700K	350	15K	045923217357	12/2 cd
S21736*	5.5G16/LED/CL/27K/E12/120V/2CD	5.5	G16 1/2	E12	120	Clear	2700K	500	15K	045923217364	12/2 cd
ST19											
S8612	4.5ST19/AMB/LED/E26/2K/120V/1CD	4.5	ST19	E26	120	Amber	2000K	380	15K	045923086120	12/1 cd
S8611	6.5ST19/CL/LED/E26/27K/120V/1CD	6.5	ST19	E26	120	Clear	2700K	810	15K	045923086113	12/1 cd

Product sheets SA2607

**See warranty for details.

Satco-Escent LED lamps

Elegance and efficiency in one package.

The most "decorative" decorative LED on the market. Adds elegance and style to any fixture even when not illuminated.

Features

- 2 Watt LED direct replacement for 25 watt incandescent lamps
- 4 Watt LED direct replacement for 40 watt incandescent lamps
- Unique satin-spun white or amber finish
- Dimmable
- Carded versions for peg board merchandising
- LED filament technology
- Approved for totally enclosed fixtures**
- Long life—15,000 hours
- 3 Year warranty



LED FILAMENT



Satco-escent LED lamps



Item No.	Description	W	Voltage	Base Type	Finish	CCT	Lm	CRI	Life/Hrs.	UPC	Case Pack
Boxed											
S11300	2CA11/LED/SA/E12/27K/120V	2	120V	E12	Satin Spun	2700K	150	80	15K	045923113000	24
S11301	2CA11/LED/A/E12/21K/120V	2	120V	E12	Amber Spun	2100K	100	80	15K	045923113017	24
S11302	4CA11/LED/SA/E12/27K/120V	4	120V	E12	Satin Spun	2700K	300	80	15K	045923113024	24
S11303	4CA11/LED/A/E12/21K/120V	4	120V	E12	Amber Spun	2100K	200	80	15K	045923113031	24
S23403	2C11/LED/SA/E26/27K/120V	2	120V	E26	Satin Spun	2700K	120	80	15K	045923234033	24
S23407	2C11/LED/A/E26/23K/120V	2	120V	E26	Amber Spun	2100K	100	80	15K	045923234071	24
S23413	4C15/LED/SA/E26/27K/120V	4	120V	E26	Satin Spun	2700K	300	80	15K	045923234132	24
S23412	4C15/LED/A/E26/23K/120V	4	120V	E26	Amber Spun	2100K	240	80	15K	045923234125	24
Carded											
S11304	2CA11/LED/SA/E12/27K/120V/CD	2	120V	E12	Satin Spun	2700K	150	80	15K	045923113048	24
S11305	2CA11/LED/A/E12/21K/120V/CD	2	120V	E12	Amber Spun	2100K	100	80	15K	045923113055	24
S11306	4CA11/LED/SA/E12/27K/120V/CD	4	120V	E12	Satin Spun	2700K	300	80	15K	045923113062	24
S11307	4CA11/LED/A/E12/21K/120V/CD	4	120V	E12	Amber Spun	2100K	200	80	15K	045923113079	24
S22703	2C11/LED/SA/E26/27K/120V/CD	2	120V	E26	Satin Spun	2700K	120	80	15K	045923227035	24
S22707	2C11/LED/A/E26/23K/120V/CD	2	120V	E26	Amber Spun	2100K	100	80	15K	045923227073	24
S22713	4C15/LED/SA/E26/27K/120V/CD	4	120V	E26	Satin Spun	2700K	300	80	15K	045923227134	24
S22712	4C15/LED/A/E26/23K/120V/CD	4	120V	E26	Amber Spun	2100K	240	80	15K	045923227127	24

Product sheets SA2320

**See warranty for details.

Carded LED specialty lamps

- Sign bulbs
- Indicator
- Nightlights
- Decorative lamps
- Non-dimmable
- Direct replacements for incandescent & specialty lamps
- LED replacements use 80% less energy
- Wet location
- Long life—25,000 hours
- 3 Year warranty



S11 Decorative A15



Carded Specialty LED Lamps

Item Number	Lamp Description	W	Base	V	Finish	CCT	Lm	M.O.L. (Inches)	Life/Hrs.	UPC	Cards
S9150	1.4W A15/CL/LED/120V/CD	1.4	Med.	120	Clear	2700K	36	3 1/16	25K	045923091506	12/1
S9151	1.4W A15/FR/LED/120V/CD	1.4	Med.	120	Frost	2700K	45	3 1/16	25K	045923091513	12/1
S9152	1W CTC/LED/120V/CD	1.0	Cand.	120	Clear	2700K	25	3 3/16	25K	045923091520	12/1
S9153	1W CFC/LED/120V/CD	1.0	Cand.	120	Clear	2700K	25	3 7/16	25K	045923091537	12/1
S9154	1.4W ETC/LED/120V/CD	1.4	Med.	120	Clear	2700K	36	3 13/16	25K	045923091544	12/1
S9155	1W CTD/LED/CRYSTAL/120V/CD	1.0	Cand.	120	Clear	2700K	25	3 3/16	25K	045923091551	12/1
S9156	0.5W C7/CL/LED/120V/CD	0.5	Cand.	120	Clear	2700K	14	2 1/16	25K	045923091568	12/1
S9157	0.5W C7/WH/LED/120V/CD	0.5	Cand.	120	White	2700K	14	2 1/16	25K	045923091575	12/1
S9158	1.4W G16.5/CL/LED/120V/CD	1.4	Med.	120	Clear	2700K	36	2 3/4	25K	045923091582	12/1
S9159	1.4W G16.5/WH/LED/120V/CD	1.4	Med.	120	White	2700K	45	2 13/16	25K	045923091599	12/1
S9160	1.2W S11/CL/LED/120V/CD	1.2	Med.	120	Clear	2700K	32	2 5/16	25K	045923091605	12/1
S9161	1.2W S11/WH/LED/120V/CD	1.2	Med.	120	White	2700K	40	2 5/16	25K	045923091612	12/1
S9162	1.2W S11/BL/LED/120V/CD	1.2	Med.	120	Blue	—	—	2 5/16	25K	045923091629	12/1
S9163	1.2W S11/GR/LED/120V/CD	1.2	Med.	120	Green	—	—	2 5/16	25K	045923091636	12/1
S9164	1.2W S11/OR/LED/120V/CD	1.2	Med.	120	Orange	—	—	2 5/16	25K	045923091643	12/1
S9165	1.2W S11/RED/LED/120V/CD	1.2	Med.	120	Red	—	—	2 5/16	25K	045923091650	12/1
S9166	1.2W S11/Y/LED/120V/CD	1.2	Med.	120	Yellow	—	—	2 5/16	25K	045923091667	12/1
S9167	1.0W S11/CL/LED/E17/120V/CD	1.0	Inter.	120	Clear	2700K	28	2 5/16	25K	045923091674	12/1
S9168	1.0W S11/WH/LED/E17/120V/CD	1.0	Inter.	120	White	2700K	35	2 5/16	25K	045923091681	12/1
S9169	1.4W S14/Y/LED/120V/CD	1.4	Med.	120	Yellow	—	—	3 5/16	25K	045923091698	12/1
S9170	1.4W S14/RED/LED/120V/CD	1.4	Med.	120	Red	—	—	3 5/16	25K	045923091704	12/1
S9171	1.4W S14/GR/LED/120V/CD	1.4	Med.	120	Green	—	—	3 5/16	25K	045923091711	12/1
S9172	1.4W S14/BL/LED/120V/CD	1.4	Med.	120	Blue	—	—	3 5/16	25K	045923091728	12/1
S9173	1.4W S14/OR/LED/120V/CD	1.4	Med.	120	Orange	—	—	3 5/16	25K	045923091735	12/1
S9174	1.4W S14/CL/LED/120V/CD	1.4	Med.	120	Clear	2700K	36	3 5/16	25K	045923091742	12/1
S9175	1.4W S14/FR/LED/120V/CD	1.4	Med.	120	Frost	2700K	45	3 5/16	25K	045923091759	12/1
S9176	0.8W T6/FR/LED/120V/CD	0.8	Cand.	120	Frost	2700K	25	2 1/16	25K	045923091766	12/1
S9177	0.8W T6/CL/LED/120V/CD	0.8	Cand.	120	Clear	2700K	20	2 1/16	25K	045923091773	12/1

Product sheet SA1529

See warranty for details.

40W replacement LED A19 lamps

Direct replacement for 40 Watt incandescent lamps, uses only 5.5-6 Watts

Indoor residential and commercial lighting

Innovative design—smooth heat sink design to resemble traditional incandescent lamp

2700K, 3000K, 3500K, 4000K & 5000K options

Damp location

Dimmable and non-dimmable options

Approved for totally enclosed fixtures**

Long life—up to 25,000 hours

ENERGY STAR certified*

3 Year warranty—10,000-15,000 hours

5 Year warranty—25,000 hours

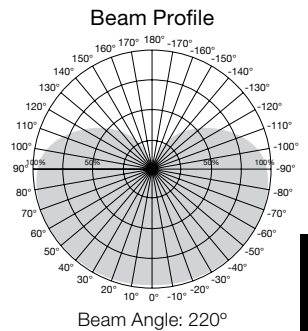

LED A-TYPE

40W Replacement A19 LED Lamps



Item Number	Lamp Description	W	V	CRI	CCT	Lm	Bm	M.O.L. (Inches)	Life/ Hrs.	UPC	Pack
Dimmable											
S29830*	6A19/OMNI/220/LED/27K	6	120	80	2700K	480	220°	4 3/16	25K	045923298301	24/6
S29831*	6A19/OMNI/220/LED/30K	6	120	80	3000K	480	220°	4 3/16	25K	045923298318	24/6
S29832*	6A19/OMNI/220/LED/35K	6	120	80	3500K	480	220°	4 3/16	25K	045923298325	24/6
S29833*	6A19/OMNI/220/LED/40K	6	120	80	4000K	480	220°	4 3/16	25K	045923298332	24/6
S29834*	6A19/OMNI/220/LED/50K	6	120	80	5000K	480	220°	4 3/16	25K	045923298349	24/6
Non-Dimmable											
S11402	5.8A19/LED/27K/120V/ECO/ND	5.8	120	80	2700K	450	220°	4 3/16	10K	045923114021	24/6
S11403	5.8A19/LED/30K/120V/ECO/ND	5.8	120	80	3000K	450	220°	4 3/16	10K	045923114038	24/6
S11404	5.8A19/LED/40K/120V/ECO/ND	5.8	120	80	4000K	450	220°	4 3/16	10K	045923114045	24/6
S11405	5.8A19/LED/50K/120V/ECO/ND	5.8	120	80	5000K	450	220°	4 3/16	10K	045923114052	24/6
S9590*	6A19/LED/2700K/120V	6	120	80	2700K	480	220°	4 3/16	15K	045923095900	24/6
S9591*	6A19/LED/3000K/120V	6	120	80	3000K	480	220°	4 3/16	15K	045923095917	24/6
S9592*	6A19/LED/5000K/120V	6	120	80	5000K	480	220°	4 3/16	15K	045923095924	24/6
90 CRI—CEC/T20 - Non-Dimmable											
S11320†■	5.5A19/LED/927/120V/D	5.5	120	90	2700K	450	220°	4 3/16	25K	045923113208	24/6
S11321†■	5.5A19/LED/930/120V/D	5.5	120	90	3000K	450	220°	4 3/16	25K	045923113215	24/6
S28557	5.5A19/LED/927/120V/ND/4Pk	5.5	120	90	2700K	450	220°	4 3/16	15K	045923285578	12-4Pks
S28558	5.5A19/LED/930/120V/ND/4Pk	5.5	120	90	3000K	450	220°	4 3/16	15K	045923285585	12-4Pks
S28593	5.5A19/LED/940/120V/ND/4Pk	5.5	120	90	4000K	450	220°	4 3/16	15K	045923285936	12-4Pks
S28594	5.5A19/LED/950/120V/ND/4Pk	5.5	120	90	5000K	450	220°	4 3/16	15K	045923285943	12-4Pks

4-Pks Must be ordered in full cases only.

Product sheet SA2648

**See warranty for details.



60W replacement LED A19 lamps

Direct replacement for 60 Watt incandescent lamps, uses only 8.5-10 Watts

Indoor residential and commercial lighting
Innovative design—smooth heat sink design to resemble traditional incandescent lamp
2700K, 3000K, 3500K, 4000K & 5000K options

Damp location

Dimmable and non-dimmable options

Approved for totally enclosed fixtures**

E26 & GU24 base options

CEC/T20 Compliant options available

Long life—up to 25,000 hours

ENERGY STAR certified*

3 Year warranty—10,000-15,000 hours

5 Year warranty—25,000 hours

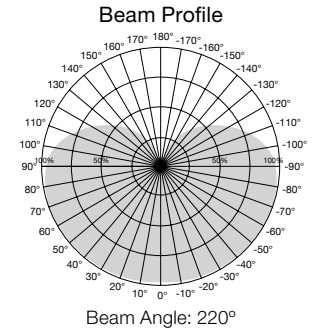

60W Replacement A19 LED Lamps

Item Number	Lamp Description	W	V	CRI	CCT	Lm	Bm	M.O.L. (Inches)	Life/Hrs.	UPC	Pack
Dimmable											
S29835*	9.8A19/OMNI/220/LED/27K	9.8	120	80	2700K	800	220°	4 5/16	25K	045923298356	24/6
S29836*	9.8A19/OMNI/220/LED/30K	9.8	120	80	3000K	800	220°	4 5/16	25K	045923298363	24/6
S29837*	9.8A19/OMNI/220/LED/35K	9.8	120	80	3500K	800	220°	4 5/16	25K	045923298370	24/6
S29838*	9.8A19/OMNI/220/LED/40K	9.8	120	80	4000K	800	220°	4 5/16	25K	045923298387	24/6
S29839*	9.8A19/OMNI/220/LED/50K	9.8	120	80	5000K	800	220°	4 5/16	25K	045923298394	24/6
S29840*	9.8A19/OMNI/220/LED/27K/GU24	9.8	120	80	2700K	800	220°	4 5/16	25K	045923298400	24/6
S29844*	9.8A19/OMNI/220/LED/30K/GU24	9.8	120	80	3000K	800	220°	4 5/16	25K	045923298448	24/6
S29841*	9.8A19/OMNI/220/LED/35K/GU24	9.8	120	80	3500K	800	220°	4 5/16	25K	045923298417	24/6
S29842*	9.8A19/OMNI/220/LED/40K/GU24	9.8	120	80	4000K	800	220°	4 5/16	25K	045923298424	24/6
S29843	9.8A19/OMNI/220/LED/50K/GU24	9.8	120	80	5000K	800	220°	4 5/16	25K	045923298431	24/6
Non-Dimmable											
S9593*	9.5A19/LED/2700K/120V	9.5	120	80	2700K	800	220°	4 5/16	15K	045923095931	24/6
S9594*	9.5A19/LED/3000K/120V	9.5	120	80	3000K	800	220°	4 5/16	15K	045923095948	24/6
S9595*	9.5A19/LED/5000K/120V	9.5	120	80	5000K	800	220°	4 5/16	15K	045923095955	24/6
S11406	9.8A19/LED/27K/120V/ECO/ND	9.8	120	80	2700K	800	220°	4 5/16	10K	045923114069	24/6
S11407	9.8A19/LED/30K/120V/ECO/ND	9.8	120	80	3000K	800	220°	4 5/16	10K	045923114076	24/6
S11408	9.8A19/LED/40K/120V/ECO/ND	9.8	120	80	4000K	800	220°	4 5/16	10K	045923114083	24/6
S11409	9.8A19/LED/50K/120V/ECO/ND	9.8	120	80	5000K	800	220°	4 5/16	10K	045923114090	24/6
120-277V Range Voltage - Non-Dimmable											
S8914*	8.5A19/LED/27K/120-277V	8.5	120-277	80	2700K	800	220°	4 5/16	25K	045923089145	24/6
S8915*	8.5A19/LED/30K/120-277V	8.5	120-277	80	3000K	800	220°	4 5/16	25K	045923089152	24/6
S8916	8.5A19/LED/40K/120-277V	8.5	120-277	80	4000K	800	220°	4 5/16	25K	045923089169	24/6
S8920	8.5A19/LED/50K/120-277V	8.5	120-277	80	5000K	800	220°	4 5/16	25K	045923089206	24/6

Product sheet SA2631

**See warranty for details.

60W replacement LED A19 lamps

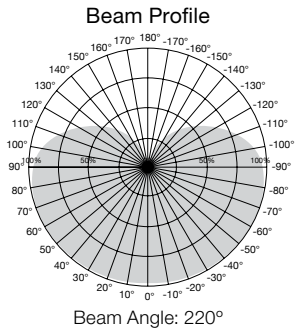

60W Replacement A19 LED Lamps

Item Number	Lamp Description	W	V	CRI	CCT	Lm	Bm	M.O.L. (Inches)	Life/Hrs.	UPC	Pack
90 CRI—CEC/T20—JA8-2016											
S9703*	10A19/OMNI/LED/27K/90CRI	10	120	90	2700K	800	220°	4 5/16	25K	045923097034	24/6
S9704*	10A19/OMNI/LED/30K/90CRI	10	120	90	3000K	800	220°	4 5/16	25K	045923097041	24/6
S8480	10A19/OMNI/LED/40K/90CRI	10	120	90	4000K	800	220°	4 5/16	25K	045923084805	24/6
S8481	10A19/OMNI/LED/50K/90CRI	10	120	90	5000K	800	220°	4 5/16	25K	045923084812	24/6
S9707*	10A19/OMNI/LED/27K/90CRI/GU24	10	120	90	2700K	800	220°	4 5/16	25K	045923097072	24/6
S9708*	10A19/OMNI/LED/30K/90CRI/GU24	10	120	90	3000K	800	220°	4 5/16	25K	045923097089	24/6
S8482	10A19/OMNI/LED/40K/90CRI/GU24	10	120	90	4000K	800	220°	4 5/16	25K	045923084829	24/6

■ Also T24 compliant.

Product sheet SA2267

Low voltage 9 Watt LED A19 lamps

- 60 Watt incandescent replacement, uses only 9 Watts
- RVs and campers
- Marine applications
- High efficiency—reduces drain on battery
- 12-34V DC
- 800 Lumens
- Long life—25,000 hours
- 3 Year warranty

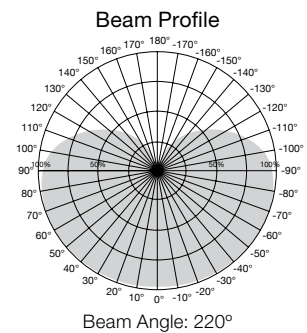

Low Voltage 9 Watt LED A19 Lamps

Item Number	Lamp Description	W	VDC	Base Type	CCT	CRI	M.O.L. (Inches)	Lm	Life/Hrs.	UPC	Pack/Master
S15011	9A19/LED/12-34VDC/827	9	12-34	E26	2700K	80	4 3/8	800	25K	045923150111	24/6
S15012	9A19/LED/12-34VDC/850	9	12-34	E26	5000K	80	4 3/8	800	25K	045923150128	24/6

Product sheet SA2476

**See warranty for details.

60W replacement LED A19 4-Pks

- Direct replacement for 60 Watt replacement incandescent lamps, uses only 9.5-10 Watts
- Indoor residential and commercial lighting
- Direct replacement for 13 Watt screw-in CFLs
- 2700K, 3000K, 4000K and 5000K options
- Damp location
- Approved for totally enclosed fixtures**
- Long life—15,000 hours
- ENERGY STAR certified*
- 3 Year warranty

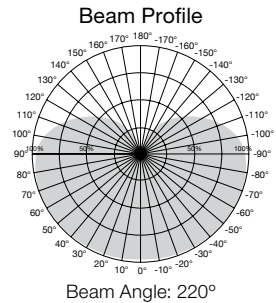

60W Replacement A19 LED Lamps 4-Pks



Item Number	Lamp Description	W	V	CRI	CCT	Lm	Bm	M.O.L. (Inches)	Life/Hrs.	UPC	Pack/Master
Dimmable											
S11414†	9.5A19/LED/827/120V/D/4Pack	9.5	120	80	2700K	800	230°	4 3/16	15K	045923114144	12 - 4Pks
S11415†	9.5A19/LED/830/120V/D/4Pack	9.5	120	80	3000K	800	230°	4 3/16	15K	045923114151	12 - 4Pks
S11416†	9.5A19/LED/840/120V/D/4Pack	9.5	120	80	4000K	800	230°	4 3/16	15K	045923114168	12 - 4Pks
S11417†	9.5A19/LED/850/120V/D/4Pack	9.5	120	80	5000K	800	230°	4 3/16	15K	045923114175	12 - 4Pks
Non-Dimmable											
S29596*	9.5A19/LED/27K/ND/120V/4Pack	9.5	120	80	2700K	800	220°	4 3/16	15K	045923295966	12 - 4Pks
S29589*	9.5A19/LED/30K/ND/120V/4Pack	9.5	120	80	3000K	800	220°	4 3/16	15K	045923295898	12 - 4Pks
S29558*	9.5A19/LED/40K/ND/120V/4Pack	9.5	120	80	4000K	800	220°	4 3/16	15K	045923295584	12 - 4Pks
S29597*	9.5A19/LED/50K/ND/120V/4Pack	9.5	120	80	5000K	800	220°	4 3/16	15K	045923295973	12 - 4Pks
90 CRI—CEC/T20 Non-Dimmable											
S28560	10A19/LED/927/120V/ND/4Pack	10	120	90	2700K	750	220°	4 3/16	15K	045923285608	12-4Pks
S28561	10A19/LED/930/120V/ND/4Pack	10	120	90	3000K	750	220°	4 3/16	15K	045923285615	12-4Pks
S28562	10A19/LED/940/120V/ND/4Pack	10	120	90	4000K	750	220°	4 3/16	15K	045923285622	12-4Pks
S28563	10A19/LED/950/120V/ND/4Pack	10	120	90	5000K	750	220°	4 3/16	15K	045923285639	12-4Pks

Must be ordered in full cases only.

Product sheet SA2659

**See warranty for details.

60W replacement LED A19 display pack

Direct replacement for 60 Watt incandescent lamps, uses only 9.5 Watts

Indoor residential and commercial lighting

Warm white 2700K

Damp location

Approved for totally enclosed fixtures**

Long life—25,000 hours

ENERGY STAR certified*

3 Year warranty

9.5 Watt 240° LED A19 Display Pks



Sold 72 per display



Item Number	Lamp Description	W	V	CRI	CCT	Lm	Bm	M.O.L. (Inches)	Life/Hrs.	UPC	Pack/Master
Dimmable											
S29629*	9.5A19/LED/2700K/800L/120V/D	9.5	120	80	2700K	800	240°	4 3/8	25K	045923096297	72
Must be ordered in full cases only.											

Product sheet SA1994

60W replacement LED A19 lamp 2-pack display

Great efficiency, even greater value – now in convenient 2-Pks

Indoor residential and commercial lighting

Great for retail end caps and counter areas

60 Watt replacement uses only 9.8 Watts

Innovative design—smooth heat sink design to resemble traditional incandescent lamp

2700K

Damp location

Approved for totally enclosed fixtures**

Long life—25,000 hours

ENERGY STAR certified*

5 Year warranty



Sold 60 2-Pks per display



60W Replacement A19 LED Lamp 2-Pks

Item Number	Lamp Description	W	V	CRI	CCT	Lm	Bm	M.O.L. (Inches)	Life/Hrs.	UPC	Pack
Dimmable											
S29699*	9.8A19/LED/2700K/800L/2Pack	9.8	120	80+	2700K	800	220°	4 3/8	25K	045923096990	60-2Pks
Must be ordered in full cases only.											

Product sheet SA2043

**See warranty for details.

60W replacement LED A19 10-Pks

- Direct replacements for 60W incandescent lamps
- Value-packed for retail or contractor sales
- 60 Watt replacement uses only 9 Watts
- Direct replacement for 13 Watt screw-in CFLs
- Indoor residential and commercial lighting
- 3000K, and 5000K options
- Damp location
- Approved for totally enclosed fixtures**
- Long life—10,000 hours
- 3 Year warranty

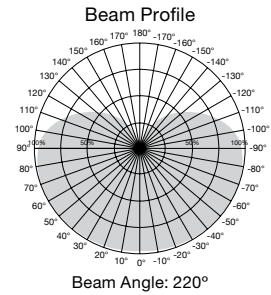

60W Replacement A19 LED A19 10 - Pack

Item Number	Lamp Description	W	V	CRI	CCT	Lm	Bm	M.O.L. (Inches)	Life/Hrs.	UPC
S11400	9A19/LED/E26/3K/120V/10Pack	9	120	80	3000K	800	220°	4 3/8	10K	045923114007
S11401	9A19/LED/E26/5K/120V/10Pack	9	120	80	5000K	800	220°	4 3/8	10K	045923114014
90 CRI – CEC/T20										
S11410	9.5A19/LED/930/120V/90CRI/10Pk	9.5	120	90	3000K	760	220°	4 3/8	10K	045923114106
S11411	9.5A19/LED/950/120V/90CRI/10Pk	9.5	120	90	5000K	760	220°	4 3/8	10K	045923114113

Master Cases 4/10 Pks

100pc Contractor pack

- Direct replacement for 60 Watt incandescent lamps or 13 Watt CFL, uses only 9 Watts 100 Per carton for easier installation and storage
- Residential and commercial lighting
- 2700K & 4000K options
- Damp location
- Approved for totally enclosed fixtures**
- 10,000 Hours
- Non-dimmable
- 3 Year warranty*



4 Trays per Master Carton



60W Replacement A19 LED Lamps - 100 Pack

Item Number	Lamp Description	W	V	Finish	CRI	Base Type	CCT	Lm	Bm	MOL	Life/Hrs.	UPC
S11412	9A19/LED/E26/827/120V/100Pk	9	120	Frosted	80	Medium	2700K	800	220°	4 3/8	10K	045923114120
S11413	9A19/LED/E26/840/120V/100Pk	9	120	Frosted	80	Medium	4000K	800	220°	4 3/8	10K	045923114137

**See warranty for details.

75W replacement LED A19 lamps

Direct replacement for 75 Watt incandescent lamps, uses only 11-13 Watts

Indoor residential and commercial lighting

Damp Location

Approved for totally enclosed fixtures**

E26 & GU24 base options

Dimmable and non-dimmable options

CEC/T20 Compliant options available

Long life—25,000 hours

ENERGY STAR certified*

3 Year warranty—15,000 hours

5 Year warranty—25,000 hours

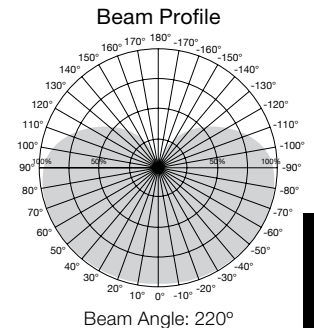

75W Replacement LED A19 Lamps

Item Number	Lamp Description	W	V	CRI	CCT	Lm	Bm	M.O.L. (Inches)	Life/Hrs.	UPC	Pack
Dimmable											
S29810*	11A19/LED/2700K/1100L/120V/D	11	120	80	2700K	1100	220°	4 5/8	25K	045923298103	24/6
S29811*	11A19/LED/3000K/1100L/120V/D	11	120	80	3000K	1100	220°	4 5/8	25K	045923298110	24/6
S29812*	11A19/LED/4000K/1100L/120V/D	11	120	80	4000K	1100	220°	4 5/8	25K	045923298127	24/6
S29813*	11A19/LED/5000K/1100L/120V/D	11	120	80	5000K	1100	220°	4 5/8	25K	045923298134	24/6
S29814*	11A19/LED/2700K/120V/D/GU24	11	120	80	2700K	1100	220°	4 5/8	25K	045923298141	24/6
S29804*	11A19/LED/4000K/120V/D/GU24	11	120	80	4000K	1100	220°	4 5/8	25K	45923298042	24/6
90 CRI—CEC/T20											
S8650*■	13A19/LED/27K/90CRI	13	120	90	2700K	1100	220°	4 5/8	25K	045923086502	24/6
S8651*■	13A19/LED/30K/90CRI	13	120	90	3000K	1100	220°	4 5/8	25K	045923086519	24/6
S8483	13A19/LED/40K/90CRI	13	120	90	4000K	1100	220°	4 5/8	25K	045923084836	24/6
S8484	13A19/LED/50K/90CRI	13	120	90	5000K	1100	220°	4 5/8	25K	045923084843	24/6
S11323†■	13A19/LED/927/120V/D/2Pk	13	120	90	2700K	1100	220°	4 5/8	25K	045923113239	12-2PKs
S11324†■	13A19/LED/927/120V/D/GU24	13	120	90	2700K	1100	220°	4 1/2	25K	045923084850	24/6
S11325†■	13A19/LED/930/120V/D/GU24	13	120	90	3000K	1100	220°	4 1/2	25K	045923113253	24/6
S8485†■	13A19/LED/940/120V/D/GU24	13	120	90	4000K	1100	220°	4 1/2	25K	045923084850	24/6
Non-Dimmable											
S28765*	11.5A19/LED/27K/ND/120V	11.5	120	80	2700K	1100	220°	4 5/8	15K	045923287657	24/6
S28766*	11.5A19/LED/30K/ND/120V	11.5	120	80	3000K	1100	220°	4 5/8	15K	045923287664	24/6
S28767*	11.5A19/LED/40K/ND/120V	11.5	120	80	4000K	1100	220°	4 5/8	15K	045923287671	24/6
S28768*	11.5A19/LED/50K/ND/120V	11.5	120	80	5000K	1100	220°	4 5/8	15K	045923287688	24/6
Left hand threaded											
S11310	10A19/LED/830/LHT	10	120	80	3000K	1050	200°	4 1/2	15K	045923113109	24
S11311	10A19/LED/840/LHT	10	120	80	4000K	1050	200°	4 1/2	15K	045923113116	24

■ Also T24 compliant.

Product sheet SA2254

**See warranty for details.

75W replacement LED A19 4-Pks

- Direct replacement for 75 Watt incandescent lamps, uses only 11.5-12.5 Watts
- Indoor residential and commercial lighting
- Direct replacement for 18 Watt screw-in CFLs
- 2700K, 3000K, 4000K and 5000K options
- Damp location
- Approved for totally enclosed fixtures**
- Long life—15,000 hours
- ENERGY STAR certified*
- 3 Year warranty

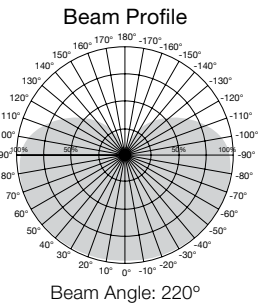

75W Replacement A19 LED 4-Pks



Item Number	Lamp Description	W	V	CRI	CCT	Lm	Bm	M.O.L. (Inches)	Life/Hrs.	UPC	Pack/Master
Non-Dimmable											
S28769*	11.5A19/LED/27K/ND/120V/4Pk	11.5	120	80	2700K	1100	220°	4 5/16	15K	045923287695	12-4Pks
S28770*	11.5A19/LED/50K/ND/120V/4Pk	11.5	120	80	5000K	1100	220°	4 5/16	15K	045923287701	12-4Pks
90 CRI—CEC/T20											
S8564	12.5A19/LED/27K/ND/120V/4Pk	12.5	120	90	2700K	1050	220°	4 3/8	15K	045923085642	12-4Pks
S8499	12.5A19/LED/30K/ND/120V/4Pk	12.5	120	90	3000K	1050	220°	4 3/8	15K	045923084997	12-4Pks
S8489	12.5A19/LED/40K/ND/120V/4Pk	12.5	120	90	4000K	1050	220°	4 3/8	15K	045923084898	12-4Pks
S8565	12.5A19/LED/50K/ND/120V/4Pk	12.5	120	90	5000K	1050	220°	4 3/8	15K	045923085659	12-4Pks

Must be ordered in full cases only.

Product sheet SA2152

**See warranty for details.

100W replacement LED A19, A21 lamps

- Direct replacement for 100 Watt incandescent lamps, uses only 15-18 Watts
- Indoor residential and commercial lighting
- Damp location
- Dimmable and non-dimmable options
- Approved for totally enclosed fixtures**
- CEC/T20 Compliant options available
- Long life—up to 25,000 hours
- ENERGY STAR certified*
- 3 Year warranty—15,000 hours
- 5 Year warranty—25,000 hours

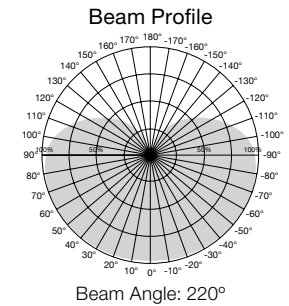

LED A-TYPE

100W Replacement LED A19 Lamps



Item Number	Lamp Description	W	V	CRI	CCT	Lm	Bm	M.O.L. (Inches)	Life/Hrs.	UPC	Pack
Dimmable											
S29815*	15A19/LED/2700K/1600L/120V/D	15	120	80	2700K	1600	220°	4 5/8	25K	045923298158	24/6
S29816*	15A19/LED/3000K/1600L/120V/D	15	120	80	3000K	1600	220°	4 5/8	25K	045923298165	24/6
S29817*	15A19/LED/4000K/1600L/120V/D	15	120	80	4000K	1600	220°	4 5/8	25K	045923298172	24/6
S29818*	15A19/LED/5000K/1600L/120V/D	15	120	80	5000K	1600	220°	4 5/8	25K	045923298189	24/6
S29819*	15A19/LED/27K/1600/120V/GU24	15	120	80	2700K	1600	220°	4 1/2	25K	045923298196	24/6
S29805*	15A19/LED/40K/1600/120V/GU24	15	120	80	4000K	1600	220°	4 1/2	25K	045923298059	24/6
90 CRI—CEC/T20											
S8652■	18A21/LED/27K/90CRI	18	120	90	2700K	1600	220°	5 5/16	25K	045923086526	24/6
S8653■	18A21/LED/30K/90CRI	18	120	90	3000K	1600	220°	5 5/16	25K	045923086533	24/6
S8486	18A21/LED/40K/90CRI	18	120	90	4000K	1600	220°	5 5/16	25K	045923084867	24/6
S8487	18A21/LED/50K/90CRI	18	120	90	5000K	1600	220°	5 5/16	25K	045923084874	24/6
S11326■	18A21/LED/927/120V/D/2Pk	18	120	90	2700K	1600	220°	5 5/8	25K	045923113260	12-2Pks
S11327■	18A21/LED/927/120V/D/GU24	18	120	90	2700K	1600	220°	5 3/8	25K	045923113277	24/6
S11328■	18A21/LED/930/120V/D/GU24	18	120	90	3000K	1600	220°	5 3/8	25K	045923113284	24/6
S8488	18A21/LED/940/120V/D/GU24	18	120	90	4000K	1600	220°	5 3/8	25K	045923084881	24/6
Non-Dimmable											
S28785*	15.5A19/LED/27K/ND/120V	15.5	120	80	2700K	1600	220°	4 5/8	15K	045923287855	24/6
S28786*	15.5A19/LED/30K/ND/120V	15.5	120	80	3000K	1600	220°	4 5/8	15K	045923287862	24/6
S28787*	15.5A19/LED/40K/ND/120V	15.5	120	80	4000K	1600	220°	4 5/8	15K	045923287879	24/6
S28788*	15.5A19/LED/50K/ND/120V	15.5	120	80	5000K	1600	220°	4 5/8	15K	045923287886	24/6

■ Also T24 compliant.

Product sheet SA2255

**See warranty for details.

100W replacement LED A19 4-Pks

Direct replacements for 100W incandescent lamps

100 Watt replacement, uses only 15.5 Watts
 Indoor residential and commercial lighting
 Direct replacement for 13, 18 & 23W screw-in CFLs
 2700K and 5000K options Damp location
 Approved for totally enclosed fixtures**
 Long life—up to 25,000 hours
 ENERGY STAR certified* 3 Year warranty

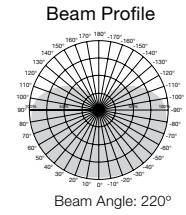

100W Replacement LED A19 4-Pks

Item Number	Lamp Description	W	V	CRI	CCT	Lm	Bm	M.O.L. (Inches)	Life/Hrs.	UPC	Pack/Master
100W Replacement											
S11422	15.5A19/LED/827/120V/D/4Pk	15.5	120	80	2700K	1600	230°	4 9/16	15K	045923114229	12-4Pk
S11423	15.5A19/LED/830/120V/D/4Pk	15.5	120	80	3000K	1600	230°	4 9/16	15K	045923114236	12-4Pk
S11424	15.5A19/LED/840/120V/D/4Pk	15.5	120	80	4000K	1600	230°	4 9/16	15K	045923114243	12-4Pk
S11425	15.5A19/LED/850/120V/D/4Pk	15.5	120	80	5000K	1600	230°	4 9/16	15K	045923114250	12-4Pk
Non-Dimmable											
S28789*	15.5A19/LED/27K/ND/120V/4Pk	15.5	120	80	2700K	1600	220°	4 5/8	15K	045923287893	12-4Pk
S28790*	15.5A19/LED/50K/ND/120V/4Pk	15.5	120	80	5000K	1600	220°	4 5/8	15K	045923287909	12-4Pk
90 CRI – CEC/T20 - Non-Dimmable											
S8566	15.5A19/LED/27K/ND/120V/4Pk	15.5	120	90	2700K	1490	220°	4 5/8	15K	045923085666	12-4Pk
S8567	15.5A19/LED/30K/ND/120V/4Pk	15.5	120	90	3000K	1490	220°	4 5/8	15K	045923085673	12-4Pk
S8490	15.5A19/LED/40K/ND/120V/4Pk	15.5	120	90	4000K	1490	220°	4 5/8	15K	045923084904	12-4Pk
S8568	15.5A19/LED/50K/ND/120V/4Pk	15.5	120	90	5000K	1490	220°	4 5/8	15K	045923085680	12-4Pk

Must be ordered in full cases only. Product sheets SA2330, SA2400, SA2180-3

125W replacement 120-277V LED A21 lamps

Direct replacement for 125 Watt incandescent & 25 Watt CFL lamps, uses only 19 Watts
 Indoor residential and commercial lighting
 Down lighting Display lighting Accent lighting
 2700K, 3000K, 4000K and 5000K options
 Damp location Approved for totally enclosed fixtures**
 c-UL-us listed Long life—25,000 hours
 ENERGY STAR certified*
 5 Year warranty

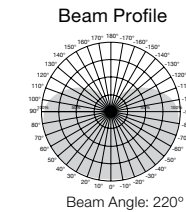

125W Replacement Omni-Directional 120-277V LED A21 Lamps

Item Number	Lamp Description	W	V	CRI	CCT	Lm	Bm	M.O.L. (Inches)	Life/Hrs.	UPC	Pack
Non-Dimmable											
S11329	20A21/LED/927/120-277V/ND	20	120-277	90	2700K	2000	220°	5 9/16	25K	045923113291	24
S11330	20A21/LED/930/120-277V/ND	20	120-277	90	3000K	2000	220°	5 9/16	25K	045923113307	24
S11331	20A21/LED/940/120-277V/ND	20	120-277	90	4000K	2000	220°	5 9/16	25K	045923113314	24
S11332	20A21/LED/950/120-277V/ND	20	120-277	90	5000K	2000	220°	5 9/16	25K	045923113321	24

Product sheet SA2696

**See warranty for details.

Hi-Pro LED A21 lamps

High lumen, A21 lamps for industrial and commercial applications

- For use in bollard and post top lighting
- High ceiling recessed lighting
- Replaces high lumen incandescent and CFL lamps
- Dimmable
- Damp location
- Saves over 80% on energy costs
- Advanced heat dissipation design
- Direct wire range voltage 120-277V options
- High efficiency—up to 150 LPW
- 2700K, 4000K and 5000K options
- Base up, base down or horizontal operation
- Long life—25,000 hours
- ENERGY STAR certified*
- 5 Year limited warranty

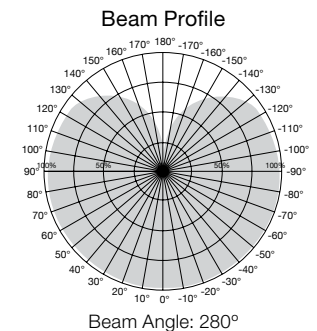

LED A-TYPE

High Lumen A21 Industrial/Commercial LED Lamps



Item Number	Lamp Description	W	V	CRI	CCT	Lm	Bm	M.O.L. (Inches)	Life/Hrs.	UPC	Pack/Master
Dimmable											
S8735*	20WA21/LED/2700K/120V/DIM/E26	20	120	80+	2700K	2350	280°	5	25K	045923087356	24/6
S8778*	20WA21/LED/4000K/120V/DIM/E26	20	120	80+	4000K	2747	280°	5	25K	045923087783	24/6
S8736*	20WA21/LED/5000K/120V/DIM/E26	20	120	80+	5000K	2860	280°	5	25K	045923087363	24/6
Non-Dimmable											
S8737*	20WA21/LED/2700K/120-277V/E26	20	120-277	80+	2700K	2450	280°	5	25K	045923087370	24/6
S8779*	20WA21/LED/4000K/120-277V/E26	20	120-277	80+	4000K	2828	280°	5	25K	045923087790	24/6
S8738*	20WA21/LED/5000K/120-277V/E26	20	120-277	80+	5000K	2910	280°	5	25K	045923087387	24/6
Accessories											
92-410	Mog to Med Socket Reducer									045923924064	10/1
80-929	Hard Wire Surge Protector									045923809293	100/1

Product sheet SA2218

**See warranty for details.

Hi-Pro LED A23 & A25 lamps

Applications

- For use in bollard and post top lighting
- High ceiling recessed lighting

Features

- Replaces high lumen incandescent and CFL lamps and A25 series up to 150W HID
- 25W - E26 and EX39 / up to 3600 lumens
- 35W - EX39 / up to 4800 lumens
- Saves over 80% on energy costs
- Advanced heat dissipation design
- Direct wire range voltage 120-277V
- High efficiency—up to 145 LPW
- 2700K, 4000K, 5000K and 6500K options
- Base up, base down or horizontal operation
- Damp location
- Long life—up to 50,000 hours
- 5 Year limited warranty



S13100



S13104

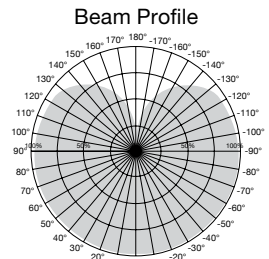

Beam Angle: 280°

High Lumen A23 & A25 Industrial/Commercial Lamps



Item Number	Lamp Description	W	V	CRI	CCT	Lm	Bm	M.O.L. (Inches)	Life/Hrs.	UPC	Pack/Mstr.
S13100**	25WA23/LED/2700K/120-277V/E26	25	120-277V	80	2700K	3375	280°	6 ¼	25K	045923131004	24
S13101**	25WA23/LED/4000K/120-277V/E26	25	120-277V	80	4000K	3575	280°	6 ¼	25K	045923131011	24
S13102**	25WA23/LED/5000K/120-277V/E26	25	120-277V	80	5000K	3625	280°	6 ¼	25K	045923131028	24
S13103	25WA23/LED/6500K/120-277V/E26	25	120-277V	80	6500K	3625	280°	6 ¼	25K	045923131035	24
S13104*	25WA23/LED/HID/2700K/120-277V/EX39	25	120-277V	80	2700K	3375	280°	6 ¾	50K	045923131042	24
S13105*	25WA23/LED/HID/4000K/120-277V/EX39	25	120-277V	80	4000K	3575	280°	6 ¾	50K	045923131059	24
S13106*	25WA23/LED/HID/5000K/120-277V/EX39	25	120-277V	80	5000K	3625	280°	6 ¾	50K	045923131066	24
S13107	25WA23/LED/HID/6500K/120-277V/EX39	25	120-277V	80	6500K	3625	280°	6 ¾	50K	045923131073	24
S13108*	35WA25/LED/HID/2700K/120-277V/EX39	35	120-277V	80	2700K	4480	280°	7 ¼	50K	045923131080	24
S13109*	35WA25/LED/HID/4000K/120-277V/EX39	35	120-277V	80	4000K	4725	280°	7 ¼	50K	045923131097	24
S13110*	35WA25/LED/HID/5000K/120-277V/EX39	35	120-277V	80	5000K	4830	280°	7 ¼	50K	045923131103	24
S13111	35WA25/LED/HID/6500K/120-277V/EX39	35	120-277V	80	6500K	4830	280°	7 ¼	50K	045923131110	24

Product sheet SA2492

**See warranty for details.

5W LED decorative flame lamp

- Outdoor fixtures
- Wall sconces
- Faux fireplaces
- Holiday lighting
- Any decorative application
- Base up or base down operation
- 120-277V
- Medium base
- Long life—20,000 hours
- c-UL-us listed
- 2 Year warranty

Multi-function options — controlled by quickly turning wall switch on-off-on

- Flame mode
- Auto slow-dim cycle
- Constant warm glow 1300K



5W LED Decorative Flame Lamps

Item Number	Lamp Description	W	Bulb Type	Base	V	CCT	M.O.L. (Inches)	Life/ Hrs.	UPC	Pack
S9806	5W/LED/FLAME BULB/120V	5	T10	E26	120-277	1300K	4 ½	20K	045923098062	24

Product sheet SA2326

60W replacement LED A19 Dusk to Dawn lamp

On at dusk, off at dawn

- Direct replacement for 60 Watt incandescent lamp uses only 8 Watts
- Indoor/outdoor residential and commercial lighting
- Automatic operation--no timers to set
- Internal sensor works in any direction
- Damp location
- Approved for totally enclosed fixtures**
- E26 Medium base
- 2700K Warm White
- Non-dimmable
- Not compatible with external photo sensors, motion sensors or timers
- c-UL-us Listed
- Long life—up to 15,000 hours
- 3 Year warranty



60W Replacement LED A19 Dusk to Dawn Lamp

Item Number	Lamp Description	Watts	Voltage	CRI	CCT	Lm	Life/ Hrs.	Beam Angle	UPC	Pack
S11421	8A19/DUSK/DAWN/LED/27K	8	120	80	2700K	800	15K	200°	045923114212	1/24

Product sheet SA2667

**See warranty for details.

3-way LED A19 & A21 lamps

Direct replacement for 30/70/100W 3-Way incandescent lamps, uses only 3/9/12W

Direct replacement for 50/100/150W 3-Way incandescent lamps uses only 5/15/21W

Indoor residential and commercial lighting

220° Omni-directional

2700K, 3000K, 4000K and 5000K options

Damp location rated

Approved for totally enclosed fixtures**

ENERGY STAR certified*

Long life—25,000 hours

3 Year warranty



3/9/12



5/15/21

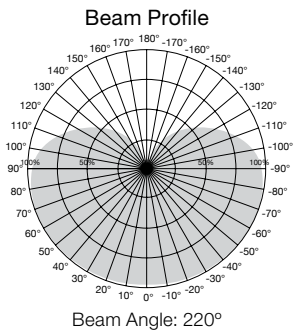

3-Way LED Lamps



Item Number	Lamp Description	W	V	CRI	CCT	Lumens	Bm	M.O.L. (Inches)	Life/ Hrs.	UPC	Pack
30/70/100W 3-Way											
S9316*	3/9/12A19/3WAY LED/2700K/120V	3/9/12	120	80	2700K	280/950/1200	220°	4 5/8	25K	045923093166	24/6
S9317*	3/9/12A19/3WAY LED/3000K/120V	3/9/12	120	80	3000K	280/950/1200	220°	4 5/8	25K	045923093173	24/6
S9318	3/9/12A19/3WAY LED/4000K/120V	3/9/12	120	80	4000K	280/950/1200	220°	4 5/8	25K	045923093180	24/6
S9319	3/9/12A19/3WAY LED/5000K/120V	3/9/12	120	80	5000K	280/950/1200	220°	4 5/8	25K	045923093197	24/6
90 CRI – CEC/T20											
S8570*	3/9/12A19/3WAY LED/27K/120V	3/9/12	120	90	2700K	230/850/1050	220°	4 5/8	25K	045923085703	24/6
S8571*	3/9/12A19/3WAY LED/30K/120V	3/9/12	120	90	3000K	230/850/1050	220°	4 5/8	25K	045923085710	24/6
50/100/150W 3-Way											
S8542*	5/15/21A21/3-WAY LED/2700K/120V	5/15/21	120	80	2700K	600/1600/2150	220°	5 5/8	25K	045923085420	24/6
S8543*	5/15/21A21/3-WAY LED/3000K/120V	5/15/21	120	80	3000K	600/1600/2150	220°	5 5/8	25K	045923085437	24/6
S8544	5/15/21A21/3-WAY LED/4000K/120V	5/15/21	120	80	4000K	600/1600/2150	220°	5 5/8	25K	045923085444	24/6
S8545	5/15/21A21/3-WAY LED/5000K/120V	5/15/21	120	80	5000K	600/1600/2150	220°	5 5/8	25K	045923085451	24/6

Product sheet SA2608

**See warranty for details.

40 & 60W Candelabra base replacement LED A19 lamps

Direct replacements for 9 and 13 Watt candelabra base CFL

Indoor residential and commercial lighting

Display lighting

Accent lighting

Dimmable

2700K, 3000K, 4000K and 5000K options

Damp location

Approved for totally enclosed fixtures**

Long life—25,000 hours

5 Year warranty

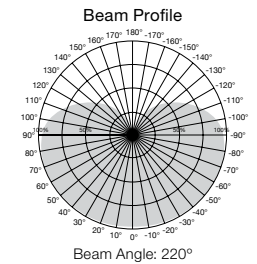

Candelabra Base A19 LED Lamps

Item Number	Lamp Description	W	V	CRI	CCT	Lm	Bm	M.O.L. (Inches)	Life/Hrs.	UPC	Pack/Master
Dimmable											
S21800*	6A19/OMNI/220/LED/E12/27K	6	120	80	2700K	480	220°	4 5/16	25K	045923218002	24/6
S21801*	6A19/OMNI/220/LED/E12/30K	6	120	80	3000K	480	220°	4 5/16	25K	045923218019	24/6
S21802	6A19/OMNI/220/LED/E12/40K	6	120	80	4000K	480	220°	4 5/16	25K	045923218026	24/6
S21803	6A19/OMNI/220/LED/E12/50K	6	120	80	5000K	480	220°	4 5/16	25K	045923218033	24/6
S21804*	9.8A19/OMNI/220/LED/E12/27K	9.8	120	80	2700K	800	220°	4 5/16	25K	045923218040	24/6
S21805*	9.8A19/OMNI/220/LED/E12/30K	9.8	120	80	3000K	800	220°	4 5/16	25K	045923218057	24/6
S21806	9.8A19/OMNI/220/LED/E12/40K	9.8	120	80	4000K	800	220°	4 5/16	25K	045923218064	24/6
S21807	9.8A19/OMNI/220/LED/E12/50K	9.8	120	80	5000K	800	220°	4 5/16	25K	045923218071	24/6

Product sheet SA2469

LED A19 colors

Direct replacement for 60 Watt incandescent lamps, uses only 8 Watts

Indoor residential and commercial lighting

Party bulbs

Display lighting

Accent lighting

Ceramic-lined glass envelopes

360° Beam angle

Damp location

Approved for totally enclosed fixtures**

Long life—15,000 hours

3 Year warranty

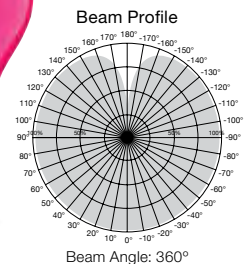

Colors for a reason

- Blue—in support of law enforcement/ Autism awareness

- Green—in support of veterans

- Yellow—bug lights

- Pink—Breast cancer awareness



Colored LED Lamps

Item Number	Lamp Description	W	V	CCT	Bm	M.O.L. (Inches)	Life/Hrs.	UPC	Pack/Mstr.
S14984	8A19/RED/LED/E26/120V	8	120	Red	360°	4 1/8	15K	045923149849	24/6
S14985	8A19/BLUE/LED/E26/120V	8	120	Blue	360°	4 1/8	15K	045923149856	24/6
S14986	8A19/GREEN/LED/E26/120V	8	120	Green	360°	4 1/8	15K	045923149863	24/6
S14987	8A19/YELLOW/E26/120V	8	120	Yellow	360°	4 1/8	15K	045923149870	24/6
S14988	8A19/ORANGE/LED/E26/120V	8	120	Orange	360°	4 1/8	15K	045923149887	24/6
S14989	8A19/PINK/LED/E26/120V	8	120	Pink	360°	4 1/8	15K	045923149894	24/6

Product sheet SA2482

**See warranty for details.

40W replacement LED A15 lamps

Direct replacement for 40 Watt A15 incandescent lamps, uses only 5.5 Watts

Indoor residential and commercial lighting

Dimmable

2700K, 3000K, 4000K and 5000K options

Damp location rated

Approved for totally enclosed fixtures**

Long life—25,000 hours

ENERGY STAR certified*

3 Year warranty



E17 Base

E26 Base

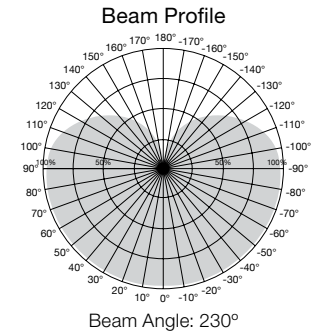

40W Replacement LED Lamps



Item Number	Lamp Description	W	V	CRI	CCT	Lm	Bm	M.O.L. (Inches)	Life/Hrs.	UPC	Pack/Master
S9030*	5.5A15/LED/2700K/120V	5.5	120	80	2700K	450	230°	3 7/16	25K	045923090301	24/6
S9031*	5.5A15/LED/3000K/120V	5.5	120	80	3000K	450	230°	3 7/16	25K	045923090318	24/6
S9032	5.5A15/LED/4000K/120V	5.5	120	80	4000K	450	230°	3 7/16	25K	045923090325	24/6
S9033	5.5A15/LED/5000K/120V	5.5	120	80	5000K	450	230°	3 7/16	25K	045923090332	24/6
S9064	5.5A15/LED/2700K/E17/120V	5.5	120	80	2700K	450	230°	3 7/16	25K	045923090646	24/6
S9065	5.5A15/LED/3000K/E17/120V	5.5	120	80	3000K	450	230°	3 1/2	25K	045923090653	24/6
S9067	5.5A15/LED/4000K/E17/120V	5.5	120	80	4000K	450	230°	3 1/2	25K	045923090677	24/6
S9068	5.5A15/LED/5000K/E17/120V	5.5	120	80	5000K	450	230°	3 1/2	25K	045923090684	24/6
90 CRI—CEC/T20											
S8572	5A15/LED/27K/120V	5	120	90	2700K	450	230°	3 15/32	25K	045923085727	24/6
S8573	5A15/LED/30K/120V	5	120	90	3000K	450	230°	3 15/32	25K	045923085734	24/6

Product sheet SA2267

**See warranty for details.

Decorative LED lamp

25W candle replacement uses only 2.8W
 40W candle replacement uses only up to 4.5W
 Accent lighting • Pendant lighting • Dimmable
 Damp location • Long life—25,000 hours
 Approved for totally enclosed fixtures**
 ENERGY STAR certified* • 5 Year warranty



Candle Beam Profile

Globe Beam Profile

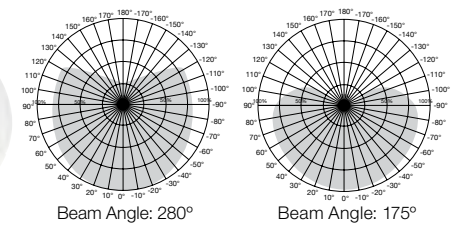

Decorative LED Lamps

Item Number	Lamp Description	W	V	CRI	CCT	Lm	Bm	M.O.L. (Inches)	Life/Hrs.	UPC	Pack
S8950	2.8CTC/LED/3000K/E12/120V	2.8	120	80	3000K	160	275°	3 ¾	25K	045923089503	12/1
S8951*	4.5CTC/LED/2700K/E12/120V	4.5	120	80	2700K	300	275°	3 ¾	25K	045923089510	12/1
S8952*	4.5CTC/LED/3000K/E12/120V	4.5	120	80	3000K	300	275°	3 ¾	25K	045923089527	12/1
S8953*	4.5ETC/LED/3000K/E26/120V	4.5	120	80	3000K	300	275°	3 ¾	25K	045923089534	12/1
90 CRI—CEC/T20											
S29618*■	3.5CTC/LED/927/E12/120V	3.5	120	90	2700K	300	290°	3 ¾	25K	045923296185	12/1
S28574	3.5CTC/LED/930/E12/120V	3.5	120	90	3000K	300	290°	3 ¾	25K	045923285745	12/1
S28617	3.5ETC/LED/927/E26/120V	3.5	120	90	2700K	300	290°	3 ¾	25K	045923286179	12/1
S28575	3.5ETC/LED/930/E26/120V	3.5	120	90	3000K	300	290°	3 ¾	25K	045923286179	12/1
GLOBES - G25											
S9200*	6G25/LED/2700K/E26	6	120	80	2700K	450	175°	4 ¼	25K	045923285752	24/6
S9201*	6G25/LED/3000K/E26	6	120	80	3000K	450	175°	4 ¼	25K	045923090530	24/6
S9202	6G25/LED/4000K/E26	6	120	80	4000K	450	175°	4 ¼	25K	045923090691	24/6
S9203	6G25/LED/5000K/E26	6	120	80	5000K	450	175°	4 ¼	25K	045923092039	24/6
90 CRI—CEC/T20											
S29619*■	4G25/LED/927/120V	4	120	90	2700K	360	170	4 ¼	25K	045923296192	24/6
S28576	4G25/LED/930/120V	4	120	90	3000K	360	170	4 ¼	25K	045923285769	24/6
S28618	4G25/LED/940/120V	4	120	90	4000K	360	170	4 ¼	25K	045923286186	24/6
S28595	4G25/LED/950/120V	4	120	90	5000K	360	170	4 ¼	25K	045923285950	24/6

■ Also T24 compliant.

Product sheet SA1370

LED Linear T10 lamps

Energy efficient alternative to traditional 35W, 60W and 150W T10 linear incandescent lamps use only 5W, 7W and 13W
 Direct replacements for LN35, LN60 and LN150 lamps
 Full PC material (bulb opaque)
 Simple installation—no ballasts or transformers required
 S14S Base • Dimmable • 2700K
 Long life—30,000 hours
 5 Year warranty



LED T10 Lamps

Item Number	Lamp Description	W	CRI	Base Type	CCT	Lm	M.O.L.* (Nominal)	Life/Hrs.	UPC	Pack
S8191	5T10/LED/27K/S14S	5	80	S14S	2700K	330	11 1/16	30K	045923081910	12
S8189	7T10/LED/27K/S14S	7	80	S14S	2700K	500	18 1/16	30K	045923081897	12
S8190	13T10/LED/27K/S14S	13	80	S14S	2700K	1000	39 3/8	30K	045923081903	12

Product sheet SA2427

**See warranty for details.

LED A-TYPE

LED squat CFL lamp replacement with GU24 base

Applications

- Indoor residential and commercial lighting
- Utility fixtures
- Closet lighting

Features

- Direct replacement for squat GU24-based CFL lamps
- 13 Watt CFL replacement uses only 9.5 Watts (60W incandescent)
- 18 Watt CFL replacement uses only 12 Watts (75W incandescent)
- GU24 base
- Uniform luminance pattern
- 2700K and 4000K options
- 90 CRI
- Approved for totally enclosed fixtures**
- Damp location
- Long life—25,000 hours
- 5 Year warranty

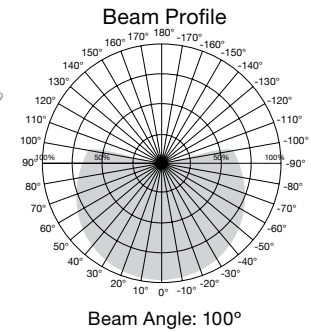

Fixtures:
90-2615
90-2616
90-2631
90-2632



LED squat CFL lamp replacement with GU24 base

Item Number	Lamp Description	W	CRI	Bulb Type	Bm	CCT	Lm	M.O.L. (Inches)	Life/Hrs.	UPC	Pack
S11540	9.5W/SQUAT/LED/27K/GU24	9.5	90	LED/GU24	100°	2700K	800	2 7/8	25K	045923115400	24
S11541	9.5W/SQUAT/LED/40K/GU24	9.5	90	LED/GU24	100°	4000K	800	2 7/8	25K	045923015410	24
S11542	12W/SQUAT/LED/27K/GU24	12	90	LED/GU24	100°	2700K	1100	2 7/8	25K	045923115424	24
S11543	12W/SQUAT/LED/40K/GU24	12	90	LED/GU24	100°	4000K	1100	2 7/8	25K	045923115431	24

**Average rated life may vary depending on application, use, fixture type and environment

**See warranty for details.

R20 LED reflectors 80 & 90 CRI

50R20 replacement uses only up to 6.5 Watts
 Indoor residential and commercial lighting
 Dimmable • Damp location • Long life—25,000 hours
 ENERGY STAR certified* • 3 Year warranty • CEC T20/T24



Beam Profile

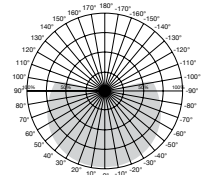

Beam Angle: 107°



6.5W R20 LED Reflectors

Item Number	Lamp Description	W	V	CRI	CCT	Lm	Bulb Type	M.O.L. (Inches)	Life/Hrs.	UPC	Pack
S9630*	6.5R20/LED/2700K/525L/120V	6.5	120	80	2700K	525	R20	3 1/16	25K	045923096303	24/6
S9631*	6.5R20/LED/3000K/525L/120V	6.5	120	80	3000K	525	R20	3 1/16	25K	045923096310	24/6
S9632*	6.5R20/LED/4000K/525L/120V	6.5	120	80	4000K	525	R20	3 1/16	25K	045923096327	24/6
S9633*	6.5R20/LED/5000K/525L/120V	6.5	120	80	5000K	525	R20	3 1/16	25K	045923096334	24/6
90 CRI—CEC/T20											
S29614*■	6R20/LED/927/120V	6	120	90	2700K	525	R20	3 1/16	25K	045923296147	24/6
S28577■	6R20/LED/930/120V	6	120	90	3000K	525	R20	3 1/16	25K	045923285776	24/6
S28491■	6R20/LED/940/120V	6	120	90	4000K	525	R20	3 1/16	25K	045923284915	24/6
S28619■	6R20/LED/950/120V	6	120	90	5000K	525	R20	3 1/16	25K	045923286193	24/6

■ Also T24 compliant.

BR30 LED reflectors 80 & 90 CRI

65BR30 replacement uses only up to 9.5 Watts
 Indoor residential and commercial lighting
 Display lighting • New one piece, lighter weight design
 Dimmable • Long life—25,000 hours
 ENERGY STAR certified*
 3 Year warranty • CEC T20/T24



Product sheet SA2629

Beam Profile

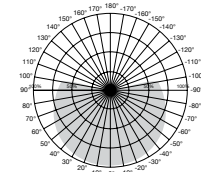

Beam Angle: 105°



9.5W BR30 LED Reflectors

Item Number	Lamp Description	W	V	CRI	CCT	Lm	Bulb Type	M.O.L. (Inches)	Life/Hrs.	UPC	Pack
S9620*	9.5BR30/LED/2700K/750L/120V/D	9.5	120	80	2700K	750	BR30	5 3/16	25K	045923096204	12/6
S9621*	9.5BR30/LED/3000K/750L/120V/D	9.5	120	80	3000K	750	BR30	5 3/16	25K	045923096211	12/6
S9622*	9.5BR30/LED/4000K/750L/120V/D	9.5	120	80	4000K	750	BR30	5 3/16	25K	045923096228	12/6
S9623*	9.5BR30/LED/5000K/750L/120V/D	9.5	120	80	5000K	750	BR30	5 3/16	25K	045923096235	12/6
S9624*	9.5BR30/LED/2700K/GU24/750L/120V	9.5	120	80	2700K	750	BR30	4 1/16	25K	045923096242	12/6
S9627	9.5BR30/LED/3000K/GU24/750L/120V	9.5	120	80	3000K	750	BR30	4 1/16	25K	045923096273	12/6

■ Also T24 compliant.

Product sheet SA1784

See warranty for details.

8W BR30 LED 2-pack display

Great efficiency, even greater value – now in convenient 2-Pks

- 65 Watt replacement uses only 8 Watts
- Indoor residential and commercial lighting
- Great for retail end caps or counter areas
- 2700K
- Dimmable*
- Damp location
- High efficiency
- Long life—25,000 hours
- ENERGY STAR certified*
- 3 Year warranty



Sold 24 2-Pks per display



8W BR30 LED 2-Pack Display

Item Number	Lamp Description	W	V	CRI	CCT	Lm	Bm	M.O.L. (Inches)	Life/Hrs.	UPC	Pack/Master
S9698*	8BR30/LED/2700K/650L/2Pack	8	120	80+	2700K	650	105°	5 3/16	25K	045923096983	24-2Pks

Must be ordered in full cases only.

Product sheet SA2042

11.5W & 16.5W BR40 LED reflectors 80 & 90 CRI

- 65W BR40 replacement uses only up to 13 Watts
- 85W BR40 replacement uses only 16.5 Watts
- Indoor residential and commercial lighting
- Dimmable
- Damp location
- Long life—25,000 hours
- ENERGY STAR certified*
- 3 Year warranty

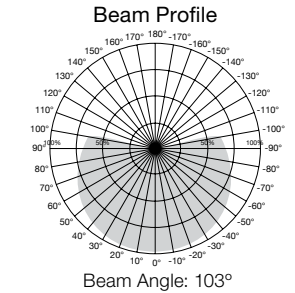

11.5, 13 & 16.5W BR40 LED Reflectors 80 & 90 CRI

Item Number	Lamp Description	W	V	CRI	CCT	Lm	Bulb Type	M.O.L. (Inches)	Life/Hrs.	UPC	Pack
S9634*	11.5BR40/LED/2700K/940L/120V	11.5	120	80	2700K	940	BR40	6 7/16	25K	045923096341	12/6
S9635*	11.5BR40/LED/3000K/940L/120V	11.5	120	80	3000K	940	BR40	6 7/16	25K	045923096358	12/6
S9636*	11.5BR40/LED/4000K/940L/120V	11.5	120	80	4000K	940	BR40	6 7/16	25K	045923096365	12/6
S9637*	11.5BR40/LED/5000K/940L/120V	11.5	120	80	5000K	940	BR40	6 7/16	25K	045923096372	12/6
S9638*	16.5BR40/LED/2700K/1200L/120V	16.5	120	80	2700K	1200	BR40	6 7/16	25K	045923096389	12/6
S9639*	16.5BR40/LED/3000K/1200L/120V	16.5	120	80	3000K	1200	BR40	6 7/16	25K	045923096396	12/6
S9640*	16.5BR40/LED/4000K/1200L/120V	16.5	120	80	4000K	1200	BR40	6 7/16	25K	045923096402	12/6
S9641*	16.5BR40/LED/5000K/1200L/120V	16.5	120	80	5000K	1200	BR40	6 7/16	25K	045923096419	12/6

90 CRI – CEC/T20

S29615*■	13BR40/LED/927/120V	13	120	90	2700K	1075	BR40	6 7/16	25K	045923296154	12/6
S28580*■	13BR40/LED/930/120V	13	120	90	3000K	1075	BR40	6 7/16	25K	045923285806	12/6
S28493*■	13BR40/LED/940/120V	13	120	90	4000K	1075	BR40	6 7/16	25K	045923284939	12/6
S28597*	13BR40/LED/950/120V	13	120	90	5000K	1075	BR40	6 7/16	25K	045923285974	12/6

■ Also T24 compliant.

Product sheet SA1812

See warranty for details.

10W BR30 LED reflector display Pks and 6 Pks

- 65W BR30 replacement uses only 10 Watts
- Indoor residential and commercial lighting
- 2700K
- Dimmable
- Damp location
- Long life—25,000 hours
- ENERGY STAR certified*
- 3 Year warranty



Display Pack



6 pack Contractor pack



10W BR30 LED Reflector

Item Number	Lamp Description	W	V	CRI	CCT	Lm	M.O.L. (Inches)	Life/Hrs.	UPC	Pack/Master
Display Pack										
S29628*	10BR30/LED/2700K/700L/120V/D	10	120	80	2700K	700	5 1/8	25K	045923296284	48
6 Packs										
S9021	10BR30/LED/827/120V/6Pk	10	120	80	2700K	700	5 1/8	25K	045923090219	4-6Pks
S9022*	10BR30/LED/830/120V/6Pk	10	120	80	3000K	700	5 1/8	25K	045923090226	4-6Pks
S9029	10BR30/LED/840/120V/6Pk	10	120	80	4000K	700	5 1/8	25K	045923090295	4-6Pks
S9058	10BR30/LED/850/120V/6PK	10	120	80	5000K	700	5 1/8	25K	045923090585	4-6Pks
90 CRI—CEC/T20										
S11420*	8.7BR30/LED/927/120V/6PK	8.7	120	80	2700K	700	5 1/8	25K	045923114205	4-6Pks

Must be ordered in full cases only.

Product sheet SA2281

7W LED PAR20 - amber

- Solid state LED lighting
- Reflector replacement lamp
- Long life—25,000 hours
- Amber color - 620nm - Sea turtle friendly



7W LED PAR20 - Amber

Item Number	Lamp Description	W	V	CCT	Lm	Bm	M.O.L. (Inches)	Life/Hrs.	UPC	Pack/Master
S29188	7PAR20/LED/40°/AMBER/120V	7	120	AMBER	340	40°	3 1/4	25K	045923291883	24/6



Product sheet SA1641

See warranty for details.

Silver PAR - Gen 2

PAR20

- Silver colored reflector
- Traditional lens
- Wet location – Indoor/Outdoor
- Dimmable
- 25°, 40° and 60° Beam spreads
- 2700K, 3000k, 3500k, 4000K and 5000k
- 90 CRI

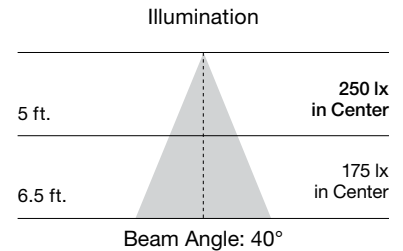
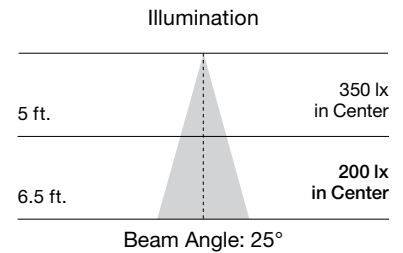

Item Number	Description	W	V	CRI	CCT	Color Temp.	Lm	Bm	M.O.L. (Inches)	Life/ Hrs.	UPC	Pack
PAR20 6.5W LED - 50W Replacement												
S29400*	6.5PAR20/LED/25/927/120V	6.5	120V	90	2700K	Warm White	520	25°	3	25K	045923294006	24/6
S29401*	6.5PAR20/LED/25/930/120V	6.5	120V	90	3000K	Soft White	520	25°	3	25K	045923294013	24/6
S29402*	6.5PAR20/LED/25/935/120V	6.5	120V	90	3500K	Neutral White	520	25°	3	25K	045923294020	24/6
S29403*	6.5PAR20/LED/25/940/120V	6.5	120V	90	4000K	Cool White	520	25°	3	25K	045923294037	24/6
S29404	6.5PAR20/LED/25/950/120V	6.5	120V	90	5000K	Natural Light	520	25°	3	25K	045923294044	24/6
S29405*	6.5PAR20/LED/40/927/120V	6.5	120V	90	2700K	Warm White	520	40°	3	25K	045923294051	24/6
S29406*	6.5PAR20/LED/40/930/120V	6.5	120V	90	3000K	Soft White	520	40°	3	25K	045923294068	24/6
S29407*	6.5PAR20/LED/40/935/120V	6.5	120V	90	3500K	Neutral White	520	40°	3	25K	045923294075	24/6
S29408*	6.5PAR20/LED/40/940/120V	6.5	120V	90	4000K	Cool White	520	40°	3	25K	045923294082	24/6
S29409	6.5PAR20/LED/40/950/120V	6.5	120V	90	5000K	Natural Light	520	40°	3	25K	045923294099	24/6

Product sheet SA2723

**See warranty for details.

PAR30/SN

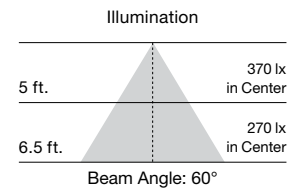
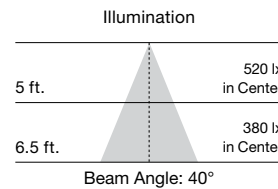
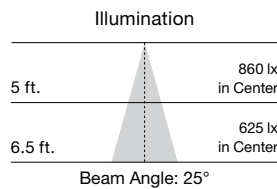

PAR30/LN

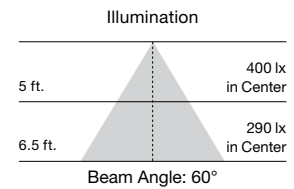
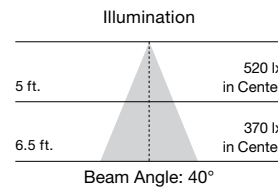
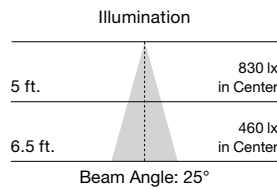

Item Number	Description	W	V	CRI	CCT	Color Temp.	Lm	Bm	M.O.L. (Inches)	Life/Hrs.	UPC	Pack
PAR30 Short Neck 13W LED - 75W Replacement												
S29410*	12.5PAR30/SN/LED/25/927/120V	12.5	120V	90	2700K	Warm White	1000	25°	3 1/16	25K	045923294105	12/6
S29411*	12.5PAR30/SN/LED/25/930/120V	12.5	120V	90	3000K	Soft White	1000	25°	3 1/16	25K	045923294112	12/6
S29412*	12.5PAR30/SN/LED/25/935/120V	12.5	120V	90	3500K	Neutral White	1000	25°	3 1/16	25K	045923294129	12/6
S29413*	12.5PAR30/SN/LED/25/940/120V	12.5	120V	90	4000K	Cool White	1000	25°	3 1/16	25K	045923294136	12/6
S29414	12.5PAR30/SN/LED/25/950/120V	12.5	120V	90	5000K	Natural Light	1000	25°	3 1/16	25K	045923294143	12/6
S29415*	12.5PAR30/SN/LED/40/927/120V	12.5	120V	90	2700K	Warm White	1000	40°	3 1/16	25K	045923294150	12/6
S29416*	12.5PAR30/SN/LED/40/930/120V	12.5	120V	90	3000K	Soft White	1000	40°	3 1/16	25K	045923294167	12/6
S29417*	12.5PAR30/SN/LED/40/935/120V	12.5	120V	90	3500K	Neutral White	1000	40°	3 1/16	25K	045923294174	12/6
S29418*	12.5PAR30/SN/LED/40/940/120V	12.5	120V	90	4000K	Cool White	1000	40°	3 1/16	25K	045923294181	12/6
S29419	12.5PAR30/SN/LED/40/950/120V	12.5	120V	90	5000K	Natural Light	1000	40°	3 1/16	25K	045923294198	12/6
S29420*	12.5PAR30/SN/LED/60/927/120V	12.5	120V	90	2700K	Warm White	1000	60°	3 1/16	25K	045923294204	12/6
S29421*	12.5PAR30/SN/LED/60/930/120V	12.5	120V	90	3000K	Soft White	1000	60°	3 1/16	25K	045923294211	12/6
S29422*	12.5PAR30/SN/LED/60/935/120V	12.5	120V	90	3500K	Neutral White	1000	60°	3 1/16	25K	045923294228	12/6
S29423*	12.5PAR30/SN/LED/60/940/120V	12.5	120V	90	4000K	Cool White	1000	60°	3 1/16	25K	045923294235	12/6
S29424	12.5PAR30/SN/LED/60/950/120V	12.5	120V	90	5000K	Natural Light	1000	60°	3 1/16	25K	045923294242	12/6
PAR30 Long Neck 13W LED - 75W Replacement												
S29425*	12.5PAR30/LN/LED/25/927/120V	12.5	120V	90	2700K	Warm White	1000	25°	4 1/16	25K	045923294259	12/6
S29426*	12.5PAR30/LN/LED/25/930/120V	12.5	120V	90	3000K	Soft White	1000	25°	4 1/16	25K	045923294266	12/6
S29427*	12.5PAR30/LN/LED/25/935/120V	12.5	120V	90	3500K	Neutral White	1000	25°	4 1/16	25K	045923294273	12/6
S29428*	12.5PAR30/LN/LED/25/940/120V	12.5	120V	90	4000K	Cool White	1000	25°	4 1/16	25K	045923294280	12/6
S29429	12.5PAR30/LN/LED/25/950/120V	12.5	120V	90	5000K	Natural Light	1000	25°	4 1/16	25K	045923294297	12/6
S29430*	12.5PAR30/LN/LED/40/927/120V	12.5	120V	90	2700K	Warm White	1000	40°	4 1/16	25K	045923294303	12/6
S29431*	12.5PAR30/LN/LED/40/930/120V	12.5	120V	90	3000K	Soft White	1000	40°	4 1/16	25K	045923294310	12/6
S29432*	12.5PAR30/LN/LED/40/935/120V	12.5	120V	90	3500K	Neutral White	1000	40°	4 1/16	25K	045923294327	12/6
S29433*	12.5PAR30/LN/LED/40/940/120V	12.5	120V	90	4000K	Cool White	1000	40°	4 1/16	25K	045923294334	12/6
S29434	12.5PAR30/LN/LED/40/950/120V	12.5	120V	90	5000K	Natural Light	1000	40°	4 1/16	25K	045923294341	12/6
S29435*	12.5PAR30/LN/LED/60/927/120V	12.5	120V	90	2700K	Warm White	1000	60°	4 1/16	25K	045923294358	12/6
S29436*	12.5PAR30/LN/LED/60/930/120V	12.5	120V	90	3000K	Soft White	1000	60°	4 1/16	25K	045923294365	12/6
S29437*	12.5PAR30/LN/LED/60/935/120V	12.5	120V	90	3500K	Neutral White	1000	60°	4 1/16	25K	045923294372	12/6
S29438*	12.5PAR30/LN/LED/60/940/120V	12.5	120V	90	4000K	Cool White	1000	60°	4 1/16	25K	045923294389	12/6
S29439	12.5PAR30/LN/LED/60/950/120V	12.5	120V	90	5000K	Natural Light	1000	60°	4 1/16	25K	045923294396	12/6

**See warranty for details.



PAR38

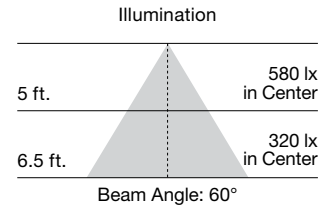
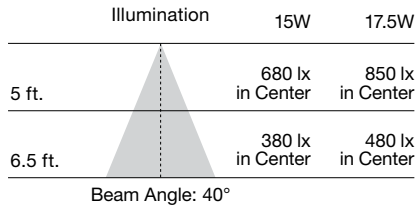
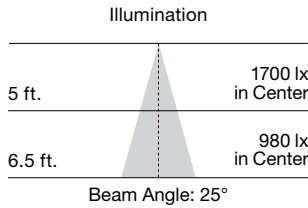

Item Number	Description	W	V	CRI	CCT	Color Temp.	Lm	Bm	M.O.L. (Inches)	Life/Hrs.	UPC	Pack
PAR 38 15W LED - 90W Replacement												
S29440*	15PAR38/LED/25/927/120V	15	120V	90	2700K	Warm White	1200	25°	5 13/16	25K	045923294402	12/6
S29441*	15PAR38/LED/25/930/120V	15	120V	90	3000K	Soft White	1200	25°	5 13/16	25K	045923294419	12/6
S29442*	15PAR38/LED/25/935/120V	15	120V	90	3500K	Neutral White	1200	25°	5 13/16	25K	045923294426	12/6
S29443*	15PAR38/LED/25/940/120V	15	120V	90	4000K	Cool White	1200	25°	5 13/16	25K	045923294433	12/6
S29444	15PAR38/LED/25/950/120V	15	120V	90	5000K	Natural Light	1200	25°	5 13/16	25K	045923294440	12/6
S29445*	15PAR38/LED/40/927/120V	15	120V	90	2700K	Warm White	1200	40°	5 13/16	25K	045923294457	12/6
S29446*	15PAR38/LED/40/930/120V	15	120V	90	3000K	Soft White	1200	40°	5 13/16	25K	045923294464	12/6
S29447*	15PAR38/LED/40/935/120V	15	120V	90	3500K	Neutral White	1200	40°	5 13/16	25K	045923294471	12/6
S29448*	15PAR38/LED/40/940/120V	15	120V	90	4000K	Cool White	1200	40°	5 13/16	25K	045923294488	12/6
S29449	15PAR38/LED/40/950/120V	15	120V	90	5000K	Natural Light	1200	40°	5 13/16	25K	045923294495	12/6
S29450*	15PAR38/LED/60/927/120V	15	120V	90	2700K	Warm White	1200	60°	5 13/16	25K	045923294501	12/6
S29451*	15PAR38/LED/60/930/120V	15	120V	90	3000K	Soft White	1200	60°	5 13/16	25K	045923294518	12/6
S29452*	15PAR38/LED/60/935/120V	15	120V	90	3500K	Neutral White	1200	60°	5 13/16	25K	045923294525	12/6
S29453*	15PAR38/LED/60/940/120V	15	120V	90	4000K	Cool White	1200	60°	5 13/16	25K	045923294532	12/6
S29454	15PAR38/LED/60/950/120V	15	120V	90	5000K	Natural Light	1200	60°	5 13/16	25K	045923294549	12/6
PAR38 17.5W LED - 120W Replacement												
S29455*	17.5PAR38/LED/40/930/120V	17.5	120V	90	3000K	Cool White	1400	40°	5 13/16	25K	045923294556	12/6
S29456*	17.5PAR38/LED/40/940/120V	17.5	120V	90	4000K	Neutral White	1400	40°	5 13/16	25K	045923294563	12/6
PAR38 15W LED 2 Pack - Non-Dimmable - 90W Replacement												
S29457*	15PAR38/LED/60/930/120V//ND/2Pk	15	120V	90	3000K	Soft White	1200	60°	5 13/16	25K	045923294570	8/2

Product sheet SA2723

**See warranty for details.

LED Silver PAR lamps G1 Series

7W LED PAR20 lamps

50W PAR20 replacement uses only 7 Watts

Down lighting

Track lighting

Dimmable

Indoor/outdoor / wet location

Approved for totally enclosed fixtures**

Long life—25,000 hours

ENERGY STAR certified*

3 Year warranty

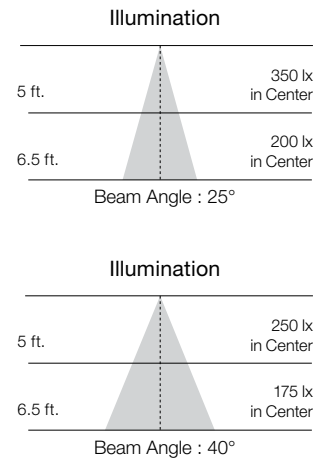

LED PAR Lamps



Item Number	Lamp Description	W	V	CRI	CCT	Color Temp.	Lm	Bm	M.O.L. (Inches)	Life/Hrs.	UPC	Pack
LED PAR20 - Replaces 50W												
S9400*	7PAR20/LED/25/2700K/120V/SP	7	120	80	2700K	Warm White	525	25°	3 1/6	25K	045923094002	24/6
S9401*	7PAR20/LED/25/3000K/120V/SP	7	120	80	3000K	Soft White	525	25°	3 1/6	25K	045923094019	24/6
S9402*	7PAR20/LED/25/3500K/120V/SP	7	120	80	3500K	Neutral White	525	25°	3 1/6	25K	045923094026	24/6
S9403*	7PAR20/LED/25/4000K/120V/SP	7	120	80	4000K	Cool White	525	25°	3 1/6	25K	045923094033	24/6
S9404*	7PAR20/LED/25/5000K/120V/SP	7	120	80	5000K	Natural Light	525	25°	3 1/6	25K	045923094040	24/6
S9405*	7PAR20/LED/40/2700K/120V/FL	7	120	80	2700K	Warm White	525	40°	3 1/6	25K	045923094057	24/6
S9406*	7PAR20/LED/40/3000K/120V/FL	7	120	80	3000K	Soft White	525	40°	3 1/6	25K	045923094064	24/6
S9407*	7PAR20/LED/40/3500K/120V/FL	7	120	80	3500K	Neutral White	525	40°	3 1/6	25K	045923094071	24/6
S9408*	7PAR20/LED/40/4000K/120V/FL	7	120	80	4000K	Cool White	525	40°	3 1/6	25K	045923094088	24/6
S9409*	7PAR20/LED/40/5000K/120V/FL	7	120	80	5000K	Natural Light	525	40°	3 1/6	25K	045923094095	24/6
90 CRI—CEC/T20												
S9485*■	7PAR20/LED/40/27K/90CRI	7	120	90	2700K	Warm White	470	40°	3	25K	045923094859	24/6
S8581*■	7PAR20/LED/40/30K/90CRI	7	120	90	3000K	Soft White	470	40°	3	25K	045923085819	24/6
S8494*	7PAR20/LED/40/40K/90CRI	7	120	90	4000K	Cool White	470	40°	3	25K	045923084942	24/6
S8598*	7PAR20/LED/40/50K/90CRI	7	120	90	5000K	Natural Light	470	40°	3	25K	045923085987	24/6

■ Also T24 compliant.

Product sheet SA1393

**See warranty for details.

13W LED PAR30 short neck lamps

- 50W PAR30 short neck replacement uses only 13 Watts
- Down lighting
- Track lighting
- Dimmable
- Indoor/outdoor/wet location
- Approved for totally enclosed fixtures**
- Long life—25,000 hours
- ENERGY STAR certified*
- 3 Year warranty

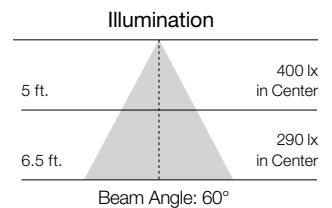
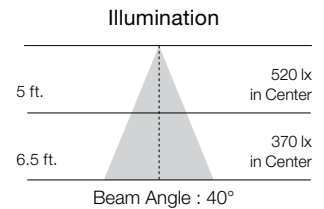
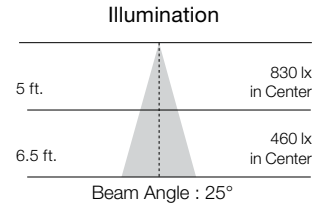

LED PAR Lamps

Item Number	Lamp Description	W	V	CRI	CCT	Color Temp.	Lm	Bm	M.O.L. (Inches)	Life/ Hrs.	UPC	Pack
LED PAR30 Short Neck - Replaces 50W												
S9410*	13PAR30/SN/LED/25/2700K/120V/SP	13	120	80	2700K	Warm White	1000	25°	3 3/8	25K	045923094101	12/6
S9411*	13PAR30/SN/LED/25/3000K/120V/SP	13	120	80	3000K	Soft White	1000	25°	3 3/8	25K	045923094118	12/6
S9412*	13PAR30/SN/LED/25/3500K/120V/SP	13	120	80	3500K	Neutral White	1000	25°	3 3/8	25K	045923094125	12/6
S9413*	13PAR30/SN/LED/25/4000K/120V/SP	13	120	80	4000K	Cool White	1000	25°	3 3/8	25K	045923094132	12/6
S9414*	13PAR30/SN/LED/25/5000K/120V/SP	13	120	80	5000K	Natural Light	1000	25°	3 3/8	25K	045923094149	12/6
S9415*	13PAR30/SN/LED/40/2700K/120V/FL	13	120	80	2700K	Warm White	1000	40°	3 3/8	25K	045923094156	12/6
S9416*	13PAR30/SN/LED/40/3000K/120V/FL	13	120	80	3000K	Soft White	1000	40°	3 3/8	25K	045923094163	12/6
S9417*	13PAR30/SN/LED/40/3500K/120V/FL	13	120	80	3500K	Neutral White	1000	40°	3 3/8	25K	045923094170	12/6
S9418*	13PAR30/SN/LED/40/4000K/120V/FL	13	120	80	4000K	Cool White	1000	40°	3 3/8	25K	045923094187	12/6
S9419*	13PAR30/SN/LED/40/5000K/120V/FL	13	120	80	5000K	Natural Light	1000	40°	3 3/8	25K	045923094194	12/6
S9420*	13PAR30/SN/LED/60/2700K/120V/WFL	13	120	80	2700K	Warm White	1000	60°	3 3/8	25K	045923094200	12/6
S9421*	13PAR30/SN/LED/60/3000K/120V/WFL	13	120	80	3000K	Soft White	1000	60°	3 3/8	25K	045923094217	12/6
S9422*	13PAR30/SN/LED/60/3500K/120V/WFL	13	120	80	3500K	Neutral White	1000	60°	3 3/8	25K	045923094224	12/6
S9423*	13PAR30/SN/LED/60/4000K/120V/WFL	13	120	80	4000K	Cool White	1000	60°	3 3/8	25K	045923094231	12/6
S9424*	13PAR30/SN/LED/60/5000K/120V/WFL	13	120	80	5000K	Natural Light	1000	60°	3 3/8	25K	045923094248	12/6
90 CRI—CEC/T20												
S9486*■	13PAR30/SN/LED/40/27K/90CRI	13	120	90	2700K	Warm White	820	40°	3 3/8	25K	045923094866	12/6
S8582*■	13PAR30/SN/LED/40/30K/90CRI	13	120	90	3000K	Soft White	820	40°	3 3/8	25K	045923085826	12/6
S8495*	13PAR30/SN/LED/40/40K/90CRI	13	120	90	4000K	Cool White	820	40°	3 3/8	25K	045923084959	12/6

■ Also T24 compliant.

Product sheet SA1393

**See warranty for details.

13W LED PAR30 long neck lamps

75W PAR30 long neck replacement uses only 13 Watts

Down lighting

Track lighting

Dimmable

Indoor/outdoor/wet location

Approved for totally enclosed fixtures**

Long life—25,000 hours

ENERGY STAR certified*

3 Year warranty

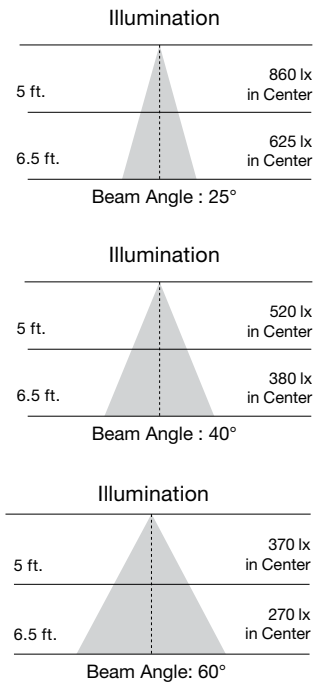

LED PAR Lamps



Item Number	Lamp Description	W	V	CRI	CCT	Color Temp.	Lm	Bm	M.O.L. (Inches)	Life/Hrs.	UPC	Pack
LED PAR30 Long Neck - Replaces 75W												
S9425*	13PAR30/LN/LED/25'/2700K/120V/SP	13	120	80	2700K	Warm White	1000	25°	4 1/8	25K	045923094255	12/6
S9426*	13PAR30/LN/LED/25'/3000K/120V/SP	13	120	80	3000K	Soft White	1000	25°	4 1/8	25K	045923094262	12/6
S9427*	13PAR30/LN/LED/25'/3500K/120V/SP	13	120	80	3500K	Neutral White	1000	25°	4 1/8	25K	045923094279	12/6
S9428*	13PAR30/LN/LED/25'/4000K/120V/SP	13	120	80	4000K	Cool White	1000	25°	4 1/8	25K	045923094286	12/6
S9429*	13PAR30/LN/LED/25'/5000K/120V/SP	13	120	80	5000K	Natural Light	1000	25°	4 1/8	25K	045923094293	12/6
S9430*	13PAR30/LN/LED/40'/2700K/120V/FL	13	120	80	2700K	Warm White	1000	40°	4 1/8	25K	045923094309	12/6
S9431*	13PAR30/LN/LED/40'/3000K/120V/FL	13	120	80	3000K	Soft White	1000	40°	4 1/8	25K	045923094316	12/6
S9432*	13PAR30/LN/LED/40'/3500K/120V/FL	13	120	80	3500K	Neutral White	1000	40°	4 1/8	25K	045923094323	12/6
S9433*	13PAR30/LN/LED/40'/4000K/120V/FL	13	120	80	4000K	Cool White	1000	40°	4 1/8	25K	045923094330	12/6
S9434*	13PAR30/LN/LED/40'/5000K/120V/FL	13	120	80	5000K	Natural Light	1000	40°	4 1/8	25K	045923094347	12/6
S9435*	13PAR30/LN/LED/60'/2700K/120V/WFL	13	120	80	2700K	Warm White	1000	60°	4 1/8	25K	045923094354	12/6
S9436*	13PAR30/LN/LED/60'/3000K/120V/WFL	13	120	80	3000K	Soft White	1000	60°	4 1/8	25K	045923094361	12/6
S9437*	13PAR30/LN/LED/60'/3500K/120V/WFL	13	120	80	3500K	Neutral White	1000	60°	4 1/8	25K	045923094378	12/6
S9438*	13PAR30/LN/LED/60'/4000K/120V/WFL	13	120	80	4000K	Cool White	1000	60°	4 1/8	25K	045923094385	12/6
S9439*	13PAR30/LN/LED/60'/5000K/120V/WFL	13	120	80	5000K	Natural Light	1000	60°	4 1/8	25K	045923094392	12/6
90 CRI—CEC/T20												
S9487*■	13PAR30/LN/LED/40'/27K/90CRI	13	120	90	2700K	Warm White	820	40°	4 1/32	25K	045923094873	12/6
S8583*■	13PAR30/LN/LED/40'/30K/90CRI	13	120	90	3000K	Soft White	820	40°	4 1/32	25K	045923085833	12/6
S8496*	13PAR30/LN/LED/40'/40K/90CRI	13	120	90	4000K	Cool White	820	40°	4 1/32	25K	045923084966	12/6

■ Also T24 compliant.

Product sheet SA1393

**See warranty for details.

15 & 18W LED PAR38 lamps

90 & 100W PAR38 replacement uses only 15-18 Watts

- Down lighting
- Track lighting
- Dimmable
- Indoor/outdoor/wet location
- Approved for totally enclosed fixtures**
- Long life—25,000 hours
- ENERGY STAR certified*
- 3 Year warranty

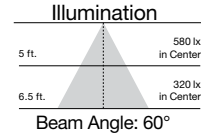
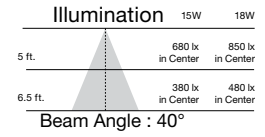
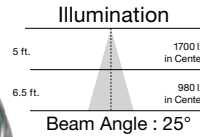

LED PAR Lamps

Item Number	Lamp Description	W	V	CRI	CCT	Color Temp.	Lm	Bm	M.O.L. (Inches)	Life/Hrs.	UPC	Pack
LED PAR38 - Replaces 90W												
S9440*	15PAR38/LED/25°/2700K/120V/SP	15	120	80	2700K	Warm White	1200	25°	5 3/16	25K	045923094408	12/6
S9441*	15PAR38/LED/25°/3000K/120V/SP	15	120	80	3000K	Soft White	1200	25°	5 3/16	25K	045923094415	12/6
S9442*	15PAR38/LED/25°/3500K/120V/SP	15	120	80	3500K	Neutral White	1200	25°	5 3/16	25K	045923094422	12/6
S9443*	15PAR38/LED/25°/4000K/120V/SP	15	120	80	4000K	Cool White	1200	25°	5 3/16	25K	045923094439	12/6
S9444*	15PAR38/LED/25°/5000K/120V/SP	15	120	80	5000K	Natural Light	1200	25°	5 3/16	25K	045923094446	12/6
S9445*	15PAR38/LED/40°/2700K/120V/FL	15	120	80	2700K	Warm White	1200	40°	5 3/16	25K	045923094453	12/6
S9446*	15PAR38/LED/40°/3000K/120V/FL	15	120	80	3000K	Soft White	1200	40°	5 3/16	25K	045923094460	12/6
S9447*	15PAR38/LED/40°/3500K/120V/FL	15	120	80	3500K	Neutral White	1200	40°	5 3/16	25K	045923094477	12/6
S9448*	15PAR38/LED/40°/4000K/120V/FL	15	120	80	4000K	Cool White	1200	40°	5 3/16	25K	045923094484	12/6
S9449*	15PAR38/LED/40°/5000K/120V/FL	15	120	80	5000K	Natural Light	1200	40°	5 3/16	25K	045923094491	12/6
S9450*	15PAR38/LED/60°/2700K/120V/WFL	15	120	80	2700K	Warm White	1200	60°	5 3/16	25K	045923094507	12/6
S9451*	15PAR38/LED/60°/3000K/120V/WFL	15	120	80	3000K	Soft White	1200	60°	5 3/16	25K	045923094514	12/6
S9452*	15PAR38/LED/60°/3500K/120V/WFL	15	120	80	3500K	Neutral White	1200	60°	5 3/16	25K	045923094521	12/6
S9453*	15PAR38/LED/60°/4000K/120V/WFL	15	120	80	4000K	Cool White	1200	60°	5 3/16	25K	045923094538	12/6
S9454*	15PAR38/LED/60°/5000K/120V/WFL	15	120	80	5000K	Natural Light	1200	60°	5 3/16	25K	045923094545	12/6
90 CRI—CEC/T20												
S9488■	15PAR38/LED/40°/27K	15	120	90	2700K	Warm White	1000	40°	5 3/16	25K	045923094880	12/6
S8584■	15PAR38/LED/40°/30K	15	120	90	3000K	Soft White	1000	40°	5 3/16	25K	045923085840	12/6
S8497*	15PAR38/LED/40°/40K	15	120	90	4000K	Cool White	1000	40°	5 3/16	25K	045923084973	12/6
S8498*	15PAR38/LED/40°/50K	15	120	90	5000K	Natural Light	1000	40°	5 3/16	25K	045923084980	12/6
LED PAR38 - Replaces 100W												
S9455*	18PAR38/LED/40°/3000K/120V/FL	18	120	80	3000K	Soft White	1400	40°	5 3/16	25K	045923094552	12/6
S9456*	18PAR38/LED/40°/4000K/120V/FL	18	120	80	4000K	Cool White	1400	40°	5 3/16	25K	045923094569	12/6
LED PAR38 - Non-Dimmable 2 Pack - Replaces 90W												
S9457*	15PAR38/LED/60°/3000K/120V/2Pack	15	120	80	3000K	Soft White	1150	60°	5 3/16	25K	045923094576	8-2Pks
LED PAR38 - Colors												
S9480	15PAR38/LED/40°/RED/120V	15	120	—	—	Red	—	40°	5 3/16	25K	045923094804	12/6
S9481	15PAR38/LED/40°/GREEN/120V	15	120	—	—	Green	—	40°	5 3/16	25K	045923094811	12/6
S9482	15PAR38/LED/40°/BLUE/120V	15	120	—	—	Blue	—	40°	5 3/16	25K	045923094828	12/6
S9483	15PAR38/LED/40°/AMBER/120V	15	120	—	—	Amber	—	40°	5 3/16	25K	045923094835	12/6
S9484	15PAR38/LED/40°/YELLOW/120V	15	120	—	—	Yellow	—	40°	5 3/16	25K	045923094842	12/6

■ Also T24 compliant.

Product sheet SA1393

**See warranty for details.

Econo LED PAR lamps

High-value LED replacements for Halogen PAR lamps

Features

- Traditional lens
- Saves over 80% on energy costs
- 120V
- 3000K and 4000K options
- 40° Beam angle
- Approved for totally enclosed fixtures**
- Wet location - indoor/outdoor
- 3 Year limited warranty**



PAR30L
S12214, S12215

PAR38
S12216, S12217



PAR30S
S12212, S12213



PAR20
S12210, S12211

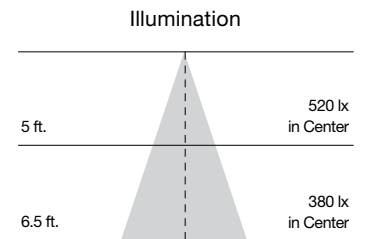

Beam Angle: 40°

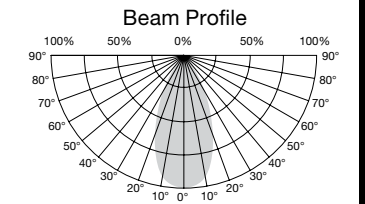

Econo PAR Lamps

Item Number	Lamp Description	W	V	CRI	CCT	Finish.	Lm	Bm	M.O.L. (Inches)	Life/ Hrs.	UPC	Pack
50 PAR20 Replacement												
S12210	6PAR20/LED/830/FL/120V	6	120	80	3000K	WHITE	500	40°	3 1/8	11K	045923122101	24
S12211	6PAR20/LED/840/FL/120V	6	120	80	4000K	WHITE	500	40°	3 1/8	11K	045923122118	24
75 PAR30 Replacement												
S12212	8.9PAR30S/LED/830/FL/120V	8.9	120	80	3000K	WHITE	700	40°	3 3/8	11K	045923122125	12
S12213	8.9PAR30S/LED/840/FL/120V	8.9	120	80	4000K	WHITE	700	40°	3 3/8	11K	045923122132	12
S12214	8.9PAR30L/LED/830/FL/120V	8.9	120	80	3000K	WHITE	700	40°	4 7/16	11K	045923122149	12
S12215	8.9PAR30L/LED/840/FL/120V	8.9	120	80	4000K	WHITE	700	40°	4 7/16	11K	045923122156	12
90 PAR38 Replacement												
S12216	13PAR38/LED/830/FL/120V	13	120	80	3000K	WHITE	1000	40°	5 1/8	11K	045923122163	12
S12217	13PAR38/LED/840/FL/120V	13	120	80	4000K	WHITE	1000	40°	5 1/8	11K	045923122170	12

**Average rated life may vary depending on application, use, fixture type and environment.

Product sheet SA2586

**See warranty for details.

High lumen LED PAR lamps

A high lumen, high efficiency option for all PAR38 and PAR30 long neck lamps

Features

- Direct replacement for 250W PAR38 lamps uses only 33 Watts
- Direct replacement for 75W PAR30LN lamps only 20.5 Watts
- Saves over 80% on energy costs
- 120V
- High efficiency
- 2700K, 3000K, 4000K, and 5000K options
- Approved for totally enclosed fixtures**
- Long life – 25,000 hours
- 3 Year limited warranty†

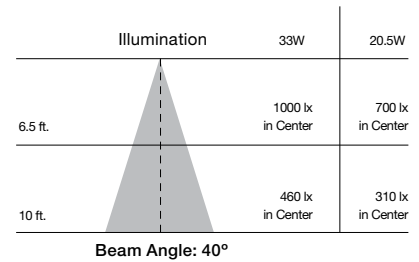
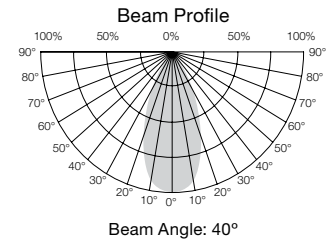

High Lumen PAR LED Lamps

Item Number	Lamp Description	W	V	CRI	CCT	Lm	Bm	M.O.L. (Inches)	Life/Hrs.	UPC
120 Volt Dimmable										
S12240	20.5PAR30LN/LED/827/HL/120V/FL/D	20.5	120V	80	2700K	1800	40°	4 7/16	25K	045923122408
S12241	20.5PAR30LN/LED/830/HL/120V/FL/D	20.5	120V	80	3000K	1800	40°	4 7/16	25K	045923122415
S12242	20.5PAR30LN/LED/840/HL/120V/FL/D	20.5	120V	80	4000K	1800	40°	4 7/16	25K	045923122422
S12243	20.5PAR30LN/LED/850/HL/120V/FL/D	20.5	120V	80	5000K	1800	40°	4 7/16	25K	045923122439
S12250*	33PAR38/LED/827/HL/120V/FL/D	33	120V	80	2700K	3000	40°	5 1/8	25K	045923122507
S12251*	33PAR38/LED/830/HL/120V/FL/D	33	120V	80	3000K	3000	40°	5 1/8	25K	045923122514
S12252*	33PAR38/LED/840/HL/120V/FL/D	33	120V	80	4000K	3000	40°	5 1/8	25K	045923122521
S12253*	33PAR38/LED/850/HL/120V/FL/D	33	120V	80	5000K	3000	40°	5 1/8	25K	045923122538

120-277 Volt Non-Dimmable										
S29764	20.5PAR30LN/930/120-277V	20.5	120-277V	90	3000K	1800	40°	4 7/16	25K	045923297649
S29765	20.5PAR30LN/940/120-277V	20.5	120-277V	90	4000K	1800	40°	4 7/16	25K	045923297656
S29760	27PAR38/930/120-277V	27	120-277V	90	3000K	2400	40°	5 3/16	25K	045923297601
S29761	27PAR38/940/120-277V	27	120-277V	90	4000K	2400	40°	5 3/16	25K	045923297618

† Average rated life may vary depending on application, use, fixture type and environment.

**See warranty for details.

Hi-Pro LED PAR30 lamps

High lumen, PAR lamps for industrial and commercial applications

- Replaces Halogen and ceramic metal Halide lamps
- Saves over 80% on energy costs
- Direct wire range voltage 100-277V
- High efficiency—100LPW
- 3000 and 4000K options
- Base up, base down or horizontal operation
- Long life—50,000 hours
- ENERGY STAR certified*
- 5 Year limited warranty



S9762, S9763

S9764, S9765

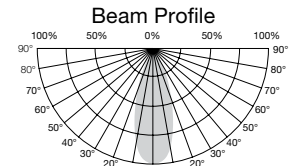

Beam Angle : 25°

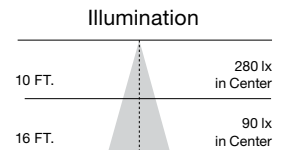

Beam Angle : 25°



High Lumen PAR30 Industrial/Commercial LED Lamps

Item Number	Lamp Description	W	V	CRI	CCT	Lm	Bm	M.O.L. (Inches)	Life/Hrs.	UPC	Pack/Master
S9762*	12W/LED/PAR30/SN/3K/100-277V	12	100-277	83	3000K	1200	25°	3 1/2	50K	045923097621	24/6
S9763*	12W/LED/PAR30/SN/4K/100-277V	12	100-277	83	4000K	1200	25°	3 1/2	50K	045923097638	24/6
S9764*	12W/LED/PAR30/LN/3K/100-277V	12	100-277	83	3000K	1200	25°	4 5/16	50K	045923097645	24/6
S9765*	12W/LED/PAR30/LN/4K/100-277V	12	100-277	83	4000K	1200	25°	4 5/16	50K	045923097652	24/6

Accessories

80-929 HARD WIRE SURGE PROTECTOR

045923809293

Product sheet SA2039

Hi-Pro LED PAR38 lamps

High lumen, PAR lamps for industrial and commercial applications

- Replaces Halogen and ceramic metal Halide lamps
- Saves over 80% on energy costs
- Direct wire range voltage 100-277V
- High efficiency—over 100LPW
- 3000 and 4000K options
- Base up, base down or horizontal operation
- Long life—50,000 hours
- ENERGY STAR certified*
- 5 Year limited warranty

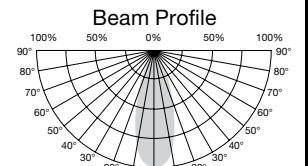

Beam Angle : 25°

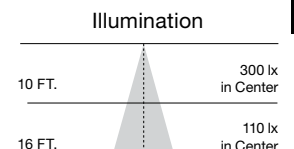

Beam Angle : 25°



High Lumen PAR38 Industrial/Commercial LED Lamps

Item Number	Lamp Description	W	V	CRI	CCT	Lm	Bm	M.O.L. (Inches)	Life/Hrs.	UPC	Pack/Master
S9760*	18W/LED/PAR38/3000K/100-277V	18	100-277	83	3000K	1950	25°	5 1/16	50K	045923097607	12/6
S9761*	18W/LED/PAR38/4000K/100-277V	18	100-277	83	4000K	2000	25°	5 1/16	50K	045923097614	12/6

Accessories

80-929 HARD WIRE SURGE PROTECTOR

045923809293

Product sheet SA2010

See warranty for details.

LED PAR16 4.5 & 6.5W lamps

45W & 60W Halogen PAR16 lamp replacement uses only 4.5-6.5 Watts

Indoor residential and commercial lighting

Down lighting

Accent lighting

Pendant lighting

Dimmable

Damp location

Approved for totally enclosed fixtures**

Long life—25,000 hours

5 Year warranty

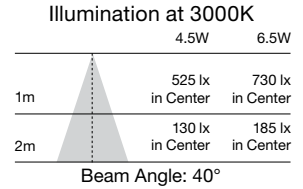
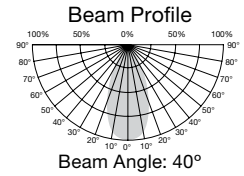

LED PAR16 Lamps

Item Number	Lamp Description	W	V	CRI	CCT	Lm	Bm	M.O.L. (Inches)	Life/Hrs.	UPC	Pack
S9386	4.5PAR16/LED/40°/3000K/120V	4.5	120	80	3000K	360	40°	2 7/8	25K	045923093869	12/1
S9387	4.5PAR16/LED/40°/5000K/120V	4.5	120	80	5000K	360	40°	2 7/8	25K	045923093876	12/1
S9388*	6.5PAR16/LED/40°/3000K/120V	6.5	120	80	3000K	500	40°	2 7/8	25K	045923093883	12/1
S9389	6.5PAR16/LED/40°/5000K/120V	6.5	120	80	5000K	500	40°	2 7/8	25K	045923093890	12/1
90 CRI—CEC/T20											
S8585	4PAR16/LED/40°/30K/120V	4	120	90	3000K	360	40°	2 7/8	25K	045923085857	12/1

Product sheet SA1744

1.6W & 3W, 12V LED MR11 lamps

20 Watt MR11 replacement, uses up to 3 Watts

Indoor residential and commercial lighting

Down lighting

Accent lighting

Pendant lighting

Non-dimmable

Damp location

Approved for totally enclosed fixtures**

Long life—25,000 hours

3 Year warranty



S9280, S9281,
S9282, S9283



S9550, S9551

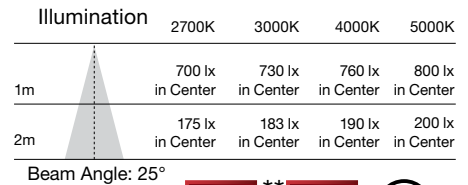
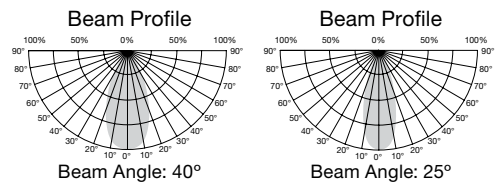

1.6W & 3W, 12V LED MR11 Lamps With GU4 Base

Item Number	Lamp Description	W	V	CRI	CCT	Lm	Bm	M.O.L. (Inches)	Life/Hrs.	UPC	Pack
S9280	3MR11/LED/25°/2700K/12V	3	12	80	2700K	210	25°	1 1/2	25K	045923092800	12/1
S9281	3MR11/LED/25°/3000K/12V	3	12	80	3000K	220	25°	1 1/2	25K	045923092817	12/1
S9282	3MR11/LED/25°/4000K/12V	3	12	80	4000K	230	25°	1 1/2	25K	045923092824	12/1
S9283	3MR11/LED/25°/5000K/12V	3	12	80	5000K	240	25°	1 1/2	25K	045923092831	12/1
S8603	3MR11/LED/25°/3000K/12V	3	12	80	3000K	210	25°	1 1/2	25K	045923086038	12/1
S9550	LED/1.6MR11/40°/3000K/12V/D	1.6	12	80	3000K	200	40°	1 1/2	25K	045923095504	20/1
S9551	LED/1.6MR11/40°/5000K/12V/D	1.6	12	80	5000K	200	40°	1 1/2	25K	045923095511	20/1

Product sheet SA1679

**See warranty for details.

LED MR16 lamps

- Down lighting
- Accent lighting
- Pendant lighting
- Dimmable
- Approved for totally enclosed fixtures**
- Long life—25,000 hours
- ENERGY STAR certified*
- 3 Year warranty



3MR16



6.5W MR16



8W MR16



LED MR16 Lamps

Item Number	Lamp Description	W	V	CRI	CCT	Lm	Bm	M.O.L. (Inches)	Life/Hrs.	UPC	Pack
S9552	LED/3MR16/40'/3000K/12V/D	3	12	80	3000K	330	40°	2	25K	045923095528	20/1
S9553	LED/3MR16/40'/5000K/12V/D	3	12	80	5000K	330	40°	2	25K	045923095535	20/1
80 CRI - 50W Replacement - CEC/T20											
S9490*	6.5MR16/LED/25'/27K/12V	6.5	12	80	2700K	500	25°	1 3/4	25K	045923094903	12/1
S9491*	6.5MR16/LED/25'/30K/12V	6.5	12	80	3000K	500	25°	1 3/4	25K	045923094910	12/1
S9492	6.5MR16/LED/25'/35K/12V	6.5	12	80	3500K	500	25°	1 3/4	25K	045923094927	12/1
S9493	6.5MR16/LED/25'/40K/12V	6.5	12	80	4000K	500	25°	1 3/4	25K	045923094934	12/1
S9494	6.5MR16/LED/25'/50K/12V	6.5	12	80	5000K	500	25°	1 3/4	25K	045923094941	12/1
S9495*	6.5MR16/LED/40'/27K/12V	6.5	12	80	2700K	500	40°	1 3/4	25K	045923094958	12/1
S9496*	6.5MR16/LED/40'/30K/12V	6.5	12	80	3000K	500	40°	1 3/4	25K	045923094965	12/1
S9497*	6.5MR16/LED/40'/35K/12V	6.5	12	80	3500K	500	40°	1 3/4	25K	045923094972	12/1
S9498*	6.5MR16/LED/40'/40K/12V	6.5	12	80	4000K	500	40°	1 3/4	25K	045923094989	12/1
S9499*	6.5MR16/LED/40'/50K/12V	6.5	12	80	5000K	500	40°	1 3/4	25K	045923094996	12/1
90 CRI											
S11334■	6.5MR16/LED/25'/927/12V	6.5	12	90	2700K	450	25°	1 3/4	25K	045923113345	48/12
S11335■	6.5MR16/LED/25'/930/12V	6.5	12	90	3000K	450	25°	1 3/4	25K	045923113352	48/12
S11336■	6.5MR16/LED/40'/927/12V	6.5	12	90	2700K	450	40°	1 3/4	25K	045923113369	48/12
S9616*■	6.5MR16/LED/40'/930/12V	6.5	12	90	3000K	450	40°	1 3/4	25K	045923096167	48/12
Single Optic - 75W Replacement - CEC/T20											
S8635	8MR16/LED/15'/27K/90CRI/12V	8	12	90	2700K	490	15°	1 7/8	25K	045923086359	12/1
S8636	8MR16/LED/15'/30K/90CRI/12V	8	12	90	3000K	490	15°	1 7/8	25K	045923086366	12/1
S8637	8MR16/LED/15'/35K/90CRI/12V	8	12	90	3500K	490	15°	1 7/8	25K	045923086373	12/1
S8638	8MR16/LED/15'/40K/90CRI/12V	8	12	90	4000K	490	15°	1 7/8	25K	045923086380	12/1
S8639	8MR16/LED/15'/50K/90CRI/12V	8	12	90	5000K	490	15°	1 7/8	25K	045923086397	12/1
S8640*	8MR16/LED/40'/27K/90CRI/12V	8	12	90	2700K	490	40°	1 7/8	25K	045923086403	12/1
S8641*	8MR16/LED/40'/30K/90CRI/12V	8	12	90	3000K	490	40°	1 7/8	25K	045923086410	12/1
S8642	8MR16/LED/40'/35K/90CRI/12V	8	12	90	3500K	490	40°	1 7/8	25K	045923086427	12/1
S8643	8MR16/LED/40'/40K/90CRI/12V	8	12	90	4000K	490	40°	1 7/8	25K	045923086434	12/1
S8644	8MR16/LED/40'/50K/90CRI/12V	8	12	90	5000K	490	40°	1 7/8	25K	045923086441	12/1

All 12V MR16 lamps are compatible with electronic and magnetic transformers. Visit www.satco.com for compatibility information and warranty details.

■ Also T24 compliant.

Product sheet SA1902

**See warranty for details.

MR16 GU10 base LED lamps

Applications

Indoor residential and commercial lighting

Down lighting

Accent lighting

Pendant lighting

Features

Direct replacement for Halogen lamps

4.5W = 35 Watts

6.5W = 50 Watts – 25° (new) and 40°

Dimmable

Damp location

Approved for enclosed fixtures**

Long life - 25,000 hours

High efficiency / environmentally friendly

Innovative design

No UV or IR radiation

5 year warranty / 10 hrs per day

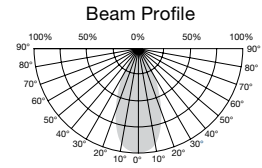

3.25 ft.	4.5W	6.5W
	565 lx in Center	760 lx in Center
6.5 ft.	141 lx in Center	190 lx in Center

Beam Angle : 40°

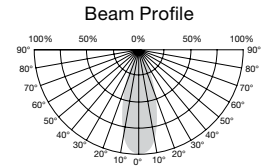

3.25 ft.	6.5W
	475 lx in Center
6.5 ft.	118 lx in Center

Beam Angle : 25°

MR16 GU10 LED Lamps



Item Number	Lamp Description	W	V	CRI	CCT	Lm	Bm	M.O.L. (Inches)	Life/ Hrs.	UPC
S9380*	4.5MR16/LED/40°/30K/120V/GU10	4.5	120	80	3000K	360	40°	2 3/16	25K	045923093807
S9381	4.5MR16/LED/40°/50K/120V/GU10	4.5	120	80	5000K	360	40°	2 3/16	25K	045923093814
S8676	6.5MR16/LED/25°/27K/120V/GU10	6.5	120	80	2700K	500	25°	2 9/32	25K	045923086762
S8677	6.5MR16/LED/25°/30K/120V/GU10	6.5	120	80	3000K	500	25°	2 9/32	25K	045923086779
S8678	6.5MR16/LED/25°/40K/120V/GU10	6.5	120	80	4000K	500	25°	2 9/32	25K	045923086786
S8679	6.5MR16/LED/25°/50K/120V/GU10	6.5	120	80	5000K	500	25°	2 9/32	25K	045923086793
S9382	6.5MR16/LED/40°/27K/120V/GU10	6.5	120	80	2700K	500	40°	2 3/16	25K	045923093821
S9383*	6.5MR16/LED/40°/30K/120V/GU10	6.5	120	80	3000K	500	40°	2 3/16	25K	045923093838
S9384	6.5MR16/LED/40°/40K/120V/GU10	6.5	120	80	4000K	500	40°	2 3/16	25K	045923093845
S9385*	6.5MR16/LED/40°/50K/120V/GU10	6.5	120	80	5000K	500	40°	2 3/16	25K	045923093852
S8603	3MR11/LED/25°/3000K/12V	3	12	80	3000K	210	25°	1 1/2	25K	045923086038

90 CRI – CEC/T20

S8588	6.5MR16/LED/40°/27K/120V/GU10	6.5	120	90+	2700K	450	40°	2 3/16	25K	045923085888
S8589*	6.5MR16/LED/40°/30K/120V/GU10	6.5	120	90+	3000K	450	40°	2 3/16	25K	045923085895

Pack Master 12/1

Product sheet SA1729

**See warranty for details.



Carded LED MR lamps

Applications

- Indoor residential and commercial lighting
- Down lighting
- Accent lighting
- Pendant lighting

Features

- Direct replacement for Halogen lamps
- 50W MR16
- 20W MR11
- Dimmable
- Damp location
- Approved for totally enclosed fixtures**
- Long life - 25,000 hours
- 3 Year warranty



LED MR Lamps - Carded



Item Number	Lamp Description	W	V	CRI	CCT	Lm	Bm	Life/Hrs.	UPC	Pack
S21741†	2MR11/LED/3K/36°/12V/ND/2CD	2	12	80	3000K	100	36°	15K	045923217418	12/2
S8603	3MR11/LED/3K/25°/12V/1CD	3	12	80	3000K	210	25°	25K	045923086038	12/1
S8604*	6.5MR16/LED/3K/40°/120V/GU10/1CD	6.5	120	80	3000K	500	40°	25K	045923086045	12/1
S8605*	6.5MR16/LED/3K/40°/12V/1CD	6.5	12	80	3000K	500	40°	25K	045923086052	12/1
S21742*	7MR16/LED/3K/40°/12V/2CD	7	12	80	3000K	600	40°	25K	045923217425	12/2
S21743*	6.5MR16/LED/3K/40°/GU10/2CD	6.5	120	80	3000K	500	40°	25K	045923217432	12/2

†Non-dimmable

Product sheet SA2674

**See warranty for details.

LED MR16 E26 base lamps

Applications

- Indoor residential and commercial lighting
- Downlighting
- Accent lighting
- Pendant lighting

Features

- Direct replacement for 50 Watt
- Halogen lamps — uses only 6.5 Watts
- Innovative design
- Dimmable
- Damp location
- Approved for enclosed fixtures**
- Long life - 25,000 hours
- No UV or IR radiation
- 3 year warranty

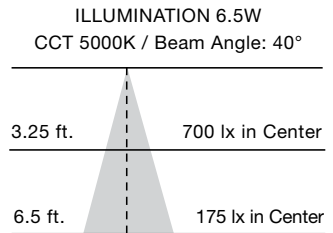
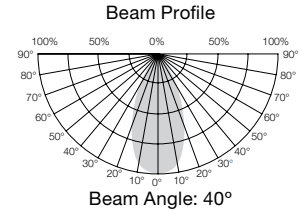

LED MR16 E26 Base Lamps



Item No.	Description	W	V	CCT	Lm	CRI	Life/Hrs.	Beam Angle	UPC
S9980	6.5MR16/E26/LED/40°/27K/120V	6.5	120V	2700K	500	80	25K	40	045923099809
S9981	6.5MR16/E26/LED/40°/30K/120V	6.5	120V	3000K	500	80	25K	40	045923099816
S9982	6.5MR16/E26/LED/40°/40K/120V	6.5	120V	4000K	500	80	25K	40	045923099823
S9983	6.5MR16/E26/LED/40°/50K/120V	6.5	120V	5000K	500	80	25K	40	045923099830

Product sheet SA2556

LED elevator lamps

- Elevator lighting
- Display lighting
- Non dimmable
- Long life—30,000 hours
- 3 Year warranty

Not for use with dimmers.
Recommended for use with magnetic transformers.
Compatibility with electronic transformers minimum load requirement must be verified.



S9005

S9004

LED Elevator Lamps

Item Number	Lamp Description	W	V	CRI	CCT	Lm	Bm	M.O.L. (Inches)	Life/Hrs.	UPC	Pack
S9005	2W/GBF/LED/12V/BA15D	2	12	80	3000K	120	40°	1 ¾	30K	045923090059	48/12
S9004	3W/1383/LED/12V/BA15S	3	12	80	3000K	120	40°	2 ½	30K	045923090042	48/12

Indoor use only. Not for use in totally enclosed fixtures.

Product sheet SA1175

**See warranty for details.

Silicon LED replacements for Halogen G4, G6.35, G8 and G9 lamps

- Solid state LED lighting
- High efficacy
- Omni-directional light
- Dimmable
- Long life—25,000 hours
- Approved for enclosed fixtures*

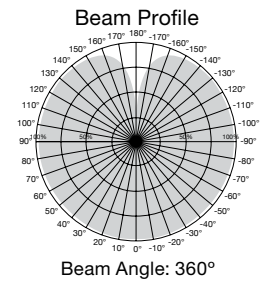
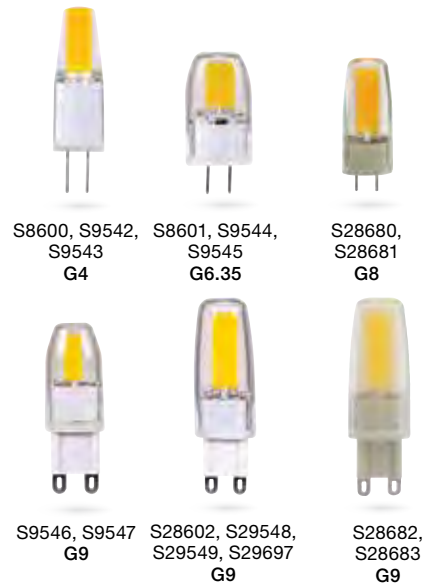

Silicon LED Replacements for Halogen G4, G6.35, G8 & G9 Lamps



Item Number	Lamp Description	W	V	Finish	Base	CRI	CCT	Lm	M.O.L. (Inches)	Life/Hrs.	UPC	Pack
G4 Bi-Pin												
S9542	LED/1.6W/JC/G4/12V/3000K/200L/360°	1.6	12	Clear	G4	80	3000K	200	1 7/16	25K	045923095429	20/1
S8600	LED/1.6W/JC/G4/12V/3K/CARDED	1.6	12	Clear	G4	80	3000K	200	1 7/16	25K	045923086007	12/1
S9543	LED/1.6W/JC/G4/12V/5000K/200L/360°	1.6	12	Clear	G4	80	5000K	200	1 7/16	25K	045923095436	20/1
G6.35												
S9544	LED/3W/JC/G6.35/12V/3000K/300L/360°	3	12	Clear	G6.35	80	3000K	300	1 5/8	25K	045923095443	20/1
S8601	LED/3W/JC/G6.35/12V/3K/CARDED	3	12	Clear	G6.35	80	3000K	300	1 5/8	25K	045923086014	12/1
S9545	LED/3W/JC/G6.35/12V/5000K/300L/360°	3	12	Clear	G6.35	80	5000K	300	1 5/8	25K	045923095450	20/1
G8												
S28680	LED/4W/JC/G8/CL/3K/120V	4	120-130	Clear	G8	80	3000K	480	2	25K	045923286803	20/1
S28681	LED/4W/JC/G8/CL/5K/120V	4	120-130	Clear	G8	80	5000K	480	2	25K	045923286810	20/1
G9												
S9546	LED/1.6W/JCD/G9/120V/3000K	1.6	120	Clear	G9	80	3000K	200	1 7/8	25K	045923095467	20/1
S9547	LED/1.6W/JCD/G9/120V/5000K	1.6	120	Clear	G9	80	5000K	200	1 7/8	25K	045923095474	20/1
S29548	LED/4W/JCD/G9/120V/3000K	4	120-130	Clear	G9	80	3000K	480	2 7/16	25K	045923295485	20/1
S28602	LED/4W/JCD/G9/120V/3K/CARDED	4	120-130	Clear	G9	80	3000K	480	2 7/16	25K	045923286025	12/1
S28682	LED/4W/JCD/G9/FR/3000K/120V	4	120-130	Frost	G9	80	3000K	460	2 7/16	25K	045923286827	20/1
S29549	LED/4W/JCD/G9/CL/120V/5000K	4	120-130	Clear	G9	80	5000K	480	2 7/16	25K	045923295492	20/1
S28683	LED/4W/JCD/G9/FR/5000K/120V	4	120-130	Frost	G9	80	5000K	460	2 7/16	25K	045923286834	20/1
S29697	LED/4W/JCD/G9/120V/3K/90CRI	4	120-130	Clear	G9	90	3000K	360	2 7/16	25K	045923296970	20/1

*Visit satco.com for use information.

**See warranty for details.

MR16 & PIN BASE

Silicon LED replacements for Halogen E11, E12, BA15D, and BA15S lamps

- Solid state LED lighting
- High efficacy
- Omni-directional light
- E11—Mini Can
- Dimmable
- Long life—25,000 hours

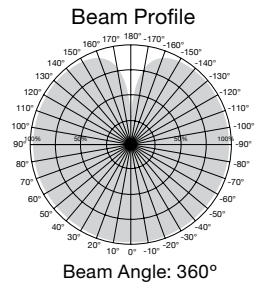

Silicon LED Replacements for Halogen E12 and BA15D Lamps

Item Number	Lamp Description	W	V	Finish	Base	CRI	CCT	Lm	M.O.L. (Inches)	Life/Hrs.	UPC	Pack
E11 Mini Can												
S28684	LED/4W/E11/MC/CL/3K/120V	4	120-130	Clear	E11	80	3000K	480	2 5/16	25K	045923286841	20/1
S28685	LED/4W/E11/MC/CL/5K/120V	4	120-130	Clear	E11	80	5000K	480	2 5/16	25K	045923286858	20/1
S28686	LED/4W/E11/MC/FR/3K/120V	4	120-130	Frost	E11	80	3000K	460	2 5/16	25K	045923286865	20/1
S28687	LED/4W/E11/MC/FR/5K/120V	4	120-130	Frost	E11	80	5000K	460	2 5/16	25K	045923286872	20/1
E12												
S11210	LED/4W/E12/CL/3K	4	120-130	Clear	E12	80	3000K	480	1/2	25K	045923112102	20/1
S11211	LED/4W/E12/CL/5K	4	120-130	Clear	E12	80	5000K	480	1/2	25K	045923112119	20/1
S11212	LED/4W/E12/FR/3K	4	120-130	Frost	E12	80	3000K	460	1/2	25K	045923112126	20/1
S11213	LED/4W/E12/FR/5K	4	120-130	Frost	E12	80	5000K	460	1/2	25K	045923112133	20/1
BA15D												
S11214	LED/4W/BA15D/CL/3K	4	120-130	Clear	BA15D	80	3000K	480	2 1/2	25K	045923112140	20/1
S11215	LED/4W/BA15D/CL/5K	4	120-130	Clear	BA15D	80	5000K	480	2 1/2	25K	045923112157	20/1
S11216	LED/4W/BA15D/FR/3K	4	120-130	Frost	BA15D	80	3000K	460	2 1/2	25K	045923112164	20/1
S11217	LED/4W/BA15D/FR/5K	4	120-130	Frost	BA15D	80	5000K	460	2 1/2	25K	045923112171	20/1
BA15S												
S8688	LED/3W/BA15S/CL/3K/12V	3	12	Clear	BA15S	80	3000K	330	1 5/16	25K	045923086885	20/1
S8689	LED/3W/BA15S/CL/5K/12V	3	12	Clear	BA15S	80	5000K	330	1 5/16	25K	045923086892	20/1

Product sheet SA2562

**See warranty for details.

4", 5/6" LED recessed downlight retrofits with selectable color temperature settings

Applications

- Residential
- Office
- Retail
- Hospitality

Features

- Selectable CCT can be set to 2700K, 3000K, 3500K, 4000K or 5000K
- Direct replacement for 50W and 65W reflector lamps - uses only 7W and 9W
- Dimmable
- Long life—50,000 hours
- Wet location - Baffle trims
- Damp location - Gimbal
- 5 Year warranty
- c-UL-us wet location listed
- ENERGY STAR® certified*

- E26 Adapter included (S9001)
- GU10 Adapter sold separately (S9000)
- GU24 Adapter sold separately (8999)



S11801



S11800



ColorQuick™
Selectable CCT Technology

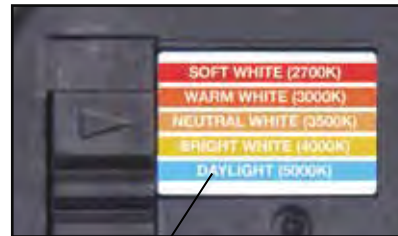

Color changeable - 5 color temperature settings

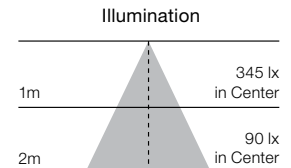
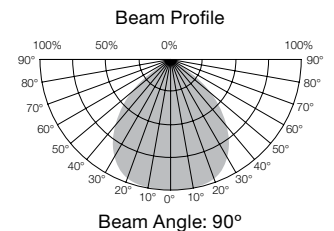

4", 5/6" LED Recessed Downlight Retrofits with Selectable Color Temperature



Item Number	Lamp Description	W	V	CRI	CCT	Lm	Bm	M.O.L. (Inches)	Life/Hrs.	UPC	Pack
Round											
S11800	7WLED/RDL/4/ADJ-CCT/120V / 4 INCH	7	120	90	27K,30K,35K,40K,50K	600	90°	2 7/8	50K	045923118005	16/1
S11801	9WLED/RDL/5-6/ADJ-CCT/120V / 5-6 INCH	9	120	90	27K,30K,35K,40K,50K	800	90°	3 1/8	50K	045923118012	8/1
S11825	13.5WLED/RDL/5-6/CCT-SEL	13.5	120	90	27K,30K,35K,40K,50K	1200	90°	3 1/4	50K	045923118258	8/1
Square											
S11820	6.5WLED/RDL/SQ/4/CCT-SEL	6.5	120	90	27K,30K,35K,40K,50K	600	90°	2 3/4	50K	045923118203	24/1
S11821	11.5WLED/RDL/SQ/5-6/CCT-SEL	11.5	120	90	27K,30K,35K,40K,50K	1000	90°	3 1/4	50K	045923118210	12/1
Gimbal											
S11822	7.5WLED/DIR/4/60°/CCT-SEL	7.5	120	90	27K,30K,35K,40K,50K	600	60°	3 1/2	50K	045923118227	8/1
S11824	10.5WLED/DIR/5-6/90°/CCT-SEL	10.5	120	90	27K,30K,35K,40K,50K	800	90°	3 7/8	50K	045923118241	8/1

Product sheet SA2632

See warranty for details.

4" LED recessed downlight retrofits

- Residential
- Office
- Retail
- Hospitality
- Solid state LED lighting
- Direct replacement for reflector lamps
- Dimmable
- c-UL-us Classified damp location - Gimbal
- c-UL-us Classified wet location - Baffle
- JA8-2016
- CEC/T20 Compliant
- Long life—50,000 hours
- ENERGY STAR® certified*
- 5 Year warranty



E26 Adapter included (S9001)
 GU10 Adapter sold separately (S9000)



4" LED Recessed Downlight Retrofits

Item Number	Lamp Description	Finish	W	V	CRI	CCT	Lm	Bm	M.O.L. (Inches)	Life/Hrs.	UPC	Pack
4" LED Baffle Retrofits												
S39713*	7WLED/RDL/4/27K/120V	White	7	120	90	2700K	600	90°	2 7/8	50K	045923397134	16/1
S39714*	7WLED/RDL/4/30K/120V	White	7	120	90	3000K	600	90°	2 7/8	50K	045923397141	16/1
S39715*	7WLED/RDL/4/40K/120V	White	7	120	90	4000K	600	90°	2 7/8	50K	045923397158	16/1
S39716*	7WLED/RDL/4/50K/120V	White	7	120	90	5000K	600	90°	2 7/8	50K	045923397165	16/1
S39744*	8.5WLED/RDL/4/30K/BN/120V	Brushed Nickel	8.5	120	90	3000K	600	90°	2 7/8	50K	045923397448	16/1
S39847*	8.5WLED/RDL/4/30K/BRZ/120V	Bronze	8.5	120	90	3000K	520	90°	2 7/8	50K	045923398476	16/1
4" LED Gimbal Retrofits												
S39463*	7WLED/DIR/4/40/27K/120V	White	7	120	90	2700K	600	40°	3 5/16	50K	045923294631	8/1
S39464*	7WLED/DIR/4/40/30K/120V	White	7	120	90	3000K	600	40°	3 5/16	50K	045923294648	8/1
S39465*	7WLED/DIR/4/40/40K/120V	White	7	120	90	4000K	600	40°	3 5/16	50K	045923294655	8/1
S39466*	7WLED/DIR/4/90/27K/120V	White	7	120	90	2700K	600	90°	3 5/16	50K	045923294662	8/1
S39467*	7WLED/DIR/4/90/30K/120V	White	7	120	90	3000K	600	90°	3 5/16	50K	045923294679	8/1
S39468*	7WLED/DIR/4/90/40K/120V	White	7	120	90	4000K	600	90°	3 5/16	50K	045923294686	8/1

■ Also T24 compliant.

Product sheet SA2602

See warranty for details.

5"/6" LED recessed downlight retrofits

- Residential • Office • Retail • Hospitality
- Solid state LED lighting
- Direct replacement for reflector lamps
- Dimmable
- High efficiency/Environmentally friendly
- c-UL-us Classified
- Damp location - Gimbal
- c-UL-us Classified
- Wet location - Baffle
- JA8-2016
- CEC/T20 Compliant
- Long life—50,000 hours
- ENERGY STAR® certified*
- 5 Year warranty

- E26 Adapter included (S9001)
- GU24 Adapter sold separately (S8999)
- GU10 Adapter sold separately (S9000)

Pressure bracket (80-2676)
alternate installation option available.

Torsion springs (80/2709)

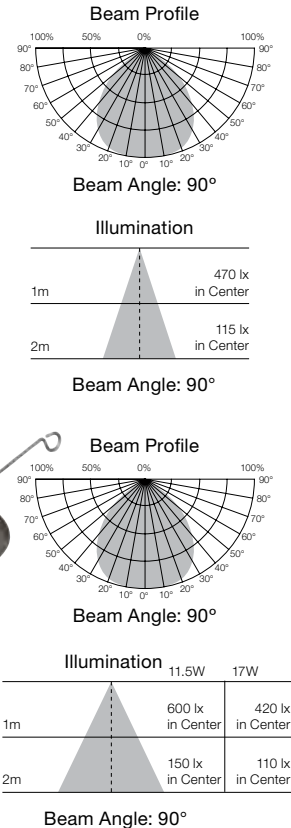

5"/6" LED Recessed Downlight Retrofits

Item Number	Lamp Description	Finish	W	V	CRI	CCT	Lm	Bm	M.O.L. (Inches)	Life/Hrs.	UPC	Pack
5"/6" LED Baffle Retrofits												
S39724■	9WLED/RDL/5-6/27K/120V	White	9	120	90	2700K	800	90°	3 7/8	50K	045923397240	8/1
S39725■	9WLED/RDL/5-6/30K/120V	White	9	120	90	3000K	800	90°	3 7/8	50K	045923397257	8/1
S39726■	9WLED/RDL/5-6/40K/120V	White	9	120	90	4000K	800	90°	3 7/8	50K	045923397264	8/1
S39727*	9WLED/RDL/5-6/50K/120V	White	9	120	90	5000K	800	90°	3 7/8	50K	045923397271	6/1
S39745*	10.5WLED/RDL/5-6/30K/BN/120V	Brushed Nickel	10.5	120	90	3000K	800	90°	3 7/8	50K	045923397455	8/1
S39848*	10.5WLED/RDL/5-6/30K/BRZ/120V	Bronze	10.5	120	90	3000K	700	90°	3 7/8	50K	045923398483	8/1
5"/6" LED Baffle Retrofits - High Lumen												
S39740■	13.5WLED/RDL/5-6/27K/120V	White	13.5	120	90	2700K	1200	90°	3 7/8	50K	045923397400	8/1
S39741■	13.5WLED/RDL/5-6/30K/120V	White	13.5	120	90	3000K	1200	90°	3 7/8	50K	045923397417	8/1
S39742■	13.5WLED/RDL/5-6/40K/120V	White	13.5	120	90	4000K	1200	90°	3 7/8	50K	045923397424	8/1
S39743*	13.5WLED/RDL/5-6/50K/120V	White	13.5	120	90	5000K	1200	90°	3 7/8	50K	045923397431	8/1
5"/6" LED Gimbal Retrofits												
S39472■	9WLED/DIR/5-6/27K/120V	White	9	120	90	2700K	800	90°	4 1/4	50K	045923394720	8/1
S39473■	9WLED/DIR/5-6/30K/120V	White	9	120	90	3000K	800	90°	4 1/4	50K	045923394737	8/1
S39474■	9WLED/DIR/5-6/40K/120V	White	9	120	90	4000K	800	90°	4 1/4	50K	045923394744	8/1

■ Also T24 compliant.

Product sheet SA2603

See warranty for details.

5"/6" LED recessed downlight retrofits

- Residential
- Office
- Retail
- Hospitality
- Direct replacement for reflector lamps
- High efficiency/environmentally friendly
- Dimmable***
- Wet location
- c-UL-us Classified
- Long life—35,000 hours
- ENERGY STAR® certified*
- 5 Year warranty

E26 Adapter included



This retrofit is for use with recessed housings with an E26 socket only.

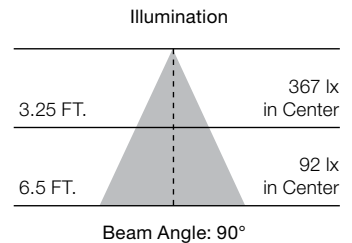

5"/6" LED Recessed Downlight Retrofits



Item Number	Lamp Description	W	V	CRI	CCT	Lm	Bm	M.O.L. (Inches)	Life/Hrs.	UPC	Pack/Master
S29312*	9.8WLED/RDL/5-6/27K/120V	9.8	120	90	2700K	650	90°	2 5/16	35K	045923293122	12/1
S29313*	9.8WLED/RDL/5-6/30K/120V	9.8	120	90	3000K	650	90°	2 5/16	35K	045923293139	12/1
S29314*	9.8WLED/RDL/5-6/40K/120V	9.8	120	90	4000K	650	90°	2 5/16	35K	045923293146	12/1
S29315*	9.8WLED/RDL/5-6/50K/120V	9.8	120	90	5000K	650	90°	2 5/16	35K	045923293153	12/1

*** Consult Satco or visit www.satco.com for an up to date dimmer compatibility list.

Product sheet SA2013

See warranty for details.

12V LED recessed downlight retrofits

- Residential • Office • Retail • Hospitality
- Dimmable
- Wet location listed
- Works with magnetic and electronic 12V transformers
- Long life—35,000 hours
- 5 Year warranty



Bi-Pin Adapter included 

12V LED Recessed Downlight Retrofits

Item Number	Lamp Description	W	V	Base	CRI	CCT	Lm	Bm	M.O.L. (Inches)	Life/Hrs.	UPC	Pack
S9729	7.5WLED/RDL/4"BFL/12V 90CRI 3K	7.5	12	GU5.3	90	3000K	460	90°	2 7/8	35K	045923097294	12/1



Product sheet SA1174

Quick Trim™ 4", 5"/6" LED recessed downlight retrofit 2-Pks

Innovative design—adjustable neck makes installation into any recessed can easy

- Residential
- Office
- Retail
- Hospitality
- Direct replacement for reflector lamps
- Dimmable***
- Damp location listed
- Long life—25,000 hours
- ENERGY STAR® certified*
- 5 Year warranty

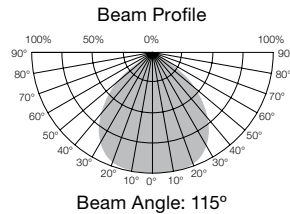

Extends to reach the socket.
Retracts to meet the surface.

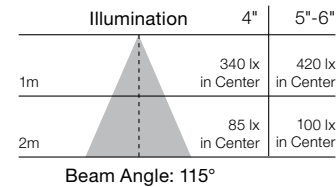

Screw lamp into existing socket.



Push into the fixture until the trim is flush against surface.



LED Recessed Downlight Retrofit 2-Pks

Item Number	Lamp Description	W	V	CRI	CCT	Lm	Bm	M.O.L. (Inches)	Life/Hrs.	UPC	Pack
S9598*	8.5WLED/4"TRIM/27K/120V/2P	8.5	120	80	2700K	510	115°	3 1/16 - 5 3/8	25K	045923095986	12-2PKs
S9599*	12WLED/5-6"TRIM/27K/120V/2P	12	120	80	2700K	800	110°	4 1/2 - 6 5/16	25K	045923095993	12-2PKs

*** Consult Satco or visit www.satco.com for an up to date dimmer compatibility list.

Product sheet SA1965

See warranty for details.

4" LED square trim recessed downlight retrofits

- 45 Watt replacement uses only 9 Watts
- Direct replacement for reflector lamps
- Residential
- Office
- Retail
- Hospitality
- Durable die-cast finish
- Dimmable***
- Wet location
- c-UL-us Classified
- JA8-2016
- CEC/T20 Compliant
- Long life—50,000 hours
- ENERGY STAR® certified*
- 5 Year warranty

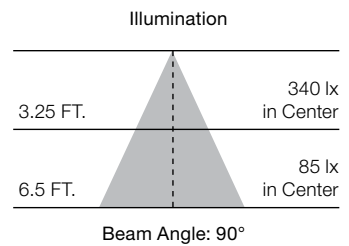
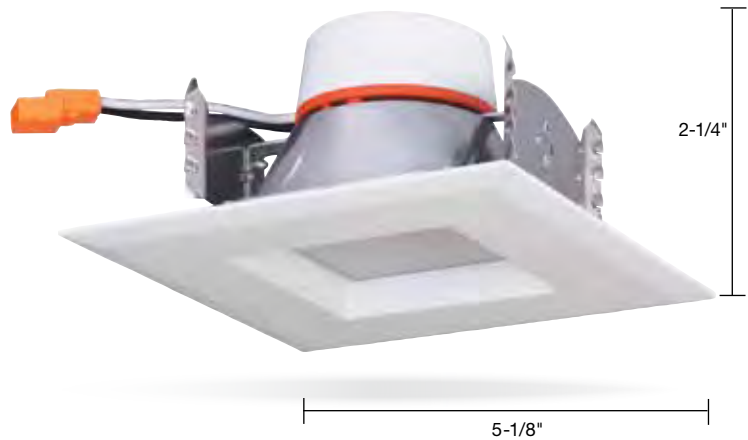

E26 Adapter included (S9001)
 GU24 Adapter sold separately (S8999)
 GU10 Adapter sold separately (S9000)
 Fits in round cans

4" LED Square Trim Recessed Downlight Retrofits



Item Number	Lamp Description	W	V	CRI	CCT	Lm	Bm	M.O.L. (Inches)	Life/ Hrs.	UPC	Pack
S39756*■	7WLED/4/SQ/27K/120V	7	120	90	2700K	600	90°	4	50K	045923397561	24/1
S39757*■	7WLED/4/SQ/30K/120V	7	120	90	3000K	600	90°	4	50K	045923397578	24/1
S39758*■	7WLED/4/SQ/40K/120V	7	120	90	4000K	600	90°	4	50K	045923397585	24/1
S39759	7WLED/4/SQ/50K/120V	7	120	90	5000K	600	90°	4	50K	045923397592	24/1

*** Consult Satco or visit www.satco.com for an up to date dimmer compatibility list. ■ Also T24 compliant.

Product sheet SA2047

See warranty for details.

5"/6" LED square trim recessed downlight retrofits

- Up to 85 Watt replacement uses only 15 Watts
- Direct replacement for reflector lamps
- Residential
- Office
- Retail
- Hospitality
- Durable die-cast finish
- Dimmable***
- Wet location
- c-UL-us Classified
- JA8-2016
- CEC/T20 Compliant
- Long life—50,000 hours
- ENERGY STAR® certified*
- 5 Year warranty

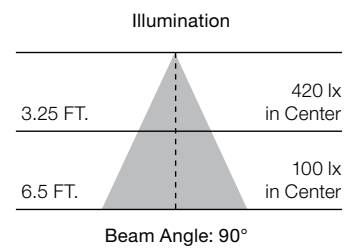

E26 Adapter included (S9001)
 GU24 Adapter sold separately (S8999)
 GU10 Adapter sold separately (S9000)
 Fits in round cans

5"/6" LED Square Trim Recessed Downlight Retrofits



Item Number	Lamp Description	W	V	CRI	CCT	Lm	Bm	M.O.L. (Inches)	Life/Hrs.	UPC	Pack
S39770*■	11.5WLED/5-6/SQ/27K/120V	11.5	120	90	2700K	1000	90°	5-6	50K	045923397707	12/1
S39771*■	11.5WLED/5-6/SQ/30K/120V	11.5	120	90	3000K	1000	90°	5-6	50K	045923397714	12/1
S39772*■	11.5WLED/5-6/SQ/40K/120V	11.5	120	90	4000K	1000	90°	5-6	50K	045923397721	12/1
S39773*	11.5WLED/5-6/SQ/50K/120V	11.5	120	90	5000K	1000	90°	5-6	50K	045923397738	12/1

*** Consult Satco or visit www.satco.com for an up to date dimmer compatibility list. ■ Also T24 compliant.

Product sheet SA2048

See warranty for details.

Hi-Pro LED lamps

Third generation, high lumen, omni-directional lamps for industrial and commercial applications

Upgraded Features

- Improved heat sink design with advanced passive heat dissipation
- Reduced size / lighter weight
- Higher efficiency, increased lumen output
- Built-in surge protection on all items
- 18W – 22W 2.5KV
- 36W – 54W 4KV
- 80W – 120W 6KV

Standard Features

- Replaces HID, CFL, and Incandescent
- Direct wire range voltage 100-277V
- Approved for totally enclosed fixtures**
- IP64-Damp location
- 3 CCT options
- High bay/low bay/post top • DLC listed*
- Long life — 50,000 hours • 5 Year limited warranty**



High Lumen Industrial/Commercial LED Lamps

Item Number	Lamp Description	Replaces Inc/CFL/HID	W	V	Base Type	CCT	Lm	M.O.L. (Inches)	Life/Hrs.	UPC	Pack/Mstr.
S39670	18W/LED/HID/2700K/100-277V/E26	120/32/70	18	100-277	E26	2700K	2340	5 1/16	50K	045923306709	24
S39390	18W/LED/HID/5000K/100-277V/E26	120/32/70	18	100-277	E26	5000K	2610	5 1/16	50K	045923303906	24
S39671	22W/LED/HID/2700K/100-277V/E26	150/40/100	22	100-277	E26	2700K	2860	5 15/16	50K	045923306716	24
S39391	22W/LED/HID/5000K/100-277V/E26	150/40/100	22	100-277	E26	5000K	3080	5 15/16	50K	045923303913	24
S39672	36W/LED/HID/2700K/100-277V/E26	200/55/150	36	100-277	E26	2700K	4680	7 3/8	50K	045923306723	12
S39392	36W/LED/HID/5000K/100-277V/E26	200/55/150	36	100-277	E26	5000K	5148	7 3/8	50K	045923303920	12
S39738	45W/LED/HID/4000K/100-277V E26	300/65/175	45	100-277	E26	4000K	6300	8 1/2	50K	045923397387	12
S39739	45W/LED/HID/5000K/100-277V E26	300/65/175	45	100-277	E26	5000K	6435	8 1/2	50K	045923397394	12
S39673*	45W/LED/HID/4000K/100-277V/EX39	300/65/175	45	100-277	EX39	4000K	6300	8 13/16	50K	045923306730	12
S39393*	45W/LED/HID/5000K/100-277V/EX39	300/65/175	45	100-277	EX39	5000K	6435	8 13/16	50K	045923303937	12
S39674*	54W/LED/HID/4000K/100-277V/EX39	300/85/250	54	100-277	EX39	4000K	7560	9	50K	045923306747	12
S39394*	54W/LED/HID/5000K/100-277V/EX39	300/85/250	54	100-277	EX39	5000K	7722	9	50K	045923303944	12
S39675*	80W/LED/HID/4000K/100-277V/EX39	400/100/320	80	100-277	EX39	4000K	11200	8 3/4	50K	045923306754	4
S39395*	80W/LED/HID/5000K/100-277V/EX39	400/100/320	80	100-277	EX39	5000K	11440	8 3/4	50K	045923303951	4
S39676*	100W/LED/HID/4000K/100-277V/EX39	500/150/400	100	100-277	EX39	4000K	14000	9 3/4	50K	045923306761	4
S39396*	100W/LED/HID/5000K/100-277V/EX39	500/150/400	100	100-277	EX39	5000K	14300	9 3/4	50K	045923303968	4
S39677*	120W/LED/HID/4000K/100-277V/EX39	750/200/600	120	100-277	EX39	4000K	16800	10 3/8	50K	045923306778	4
S39397*	120W/LED/HID/5000K/100-277V/EX39	750/200/600	120	100-277	EX39	5000K	17160	10 3/8	50K	045923303975	4

Accessories

92-406	Mog to Med Socket Reducer for S39390, S39391, S39392, S39670, S39671 and S39672	045923924064
80-929	Hard Wire Surge Protector	045923809293

** For minimum compartment size of enclosed fixture visit www.satco.com. Lamp life may vary depending on application and use. See warranty for details.

Product sheet SA2320

**See warranty for details.

Hi-Pro 277-347V high lumen LED lamps

High lumen, omni-directional lamps for industrial and commercial applications

HI-PRO HID REPLACEMENTS

- Replaces HID, CFL, and Incandescent
- Direct wire range voltage 277-347V
- Built-in surge protection 80-120W
- Approved for totally enclosed fixtures**
- IP65 rated
- 5000K
- Beam angle 300°
- CRI 80+
- High bay/low bay/post top
- DLC listed*
- 5 Year limited warranty



S28710, S28711
S28712

S28713, S28714

S28715, S28716

S28717

Stocked in Canada only.

High Lumen Industrial/Commercial 277-347V LED Lamps



Item Number	Lamp Description	Replaces Inc/CFL/HID	W	V	Base Type	CCT	Lm	M.O.L. (Inches)	Life/ Hrs.	UPC	Pack/ Mstr.
S28710	18W/LED/HID/5000K/277-347V/E26	120/32/70	18	277-347	E26	5000K	2400	6 3/4	40K	045923287107	48
S28711	22W/LED/HID/5000K/277-347V/E26	150/40/100	22	277-347	E26	5000K	2950	6 1/16	40K	045923287114	48
S28712	36W/LED/HID/5000K/277-347V/E26	200/55/150	36	277-347	E26	5000K	4800	9 3/16	40K	045923287121	12
S28713*	45W/LED/HID/5000K/277-347V/EX39	300/65/175	45	277-347	EX39	5000K	6000	10 1/16	40K	045923287138	12
S28714*	54W/LED/HID/5000K/277-347V/EX39	300/85/250	54	277-347	EX39	5000K	7200	10 1/16	40K	045923287145	12
S28715*	80W/LED/HID/5000K/277-347V/EX39	400/100/320	80	277-347	EX39	5000K	10640	9 1/4	40K	045923287152	4
S28716*	100W/LED/HID/5000K/277-347V/EX39	500/150/400	100	277-347	EX39	5000K	13300	9 5/8	40K	045923287169	4
S28717*	120W/LED/HID/5000K/277-347V/EX39	750/200/600	120	277-347	EX39	5000K	16000	10 3/8	40K	045923287176	4

Accessories

92-410	Mog to Med Socket Reducer	045923924064
80-935	Hard Wire Surge Protector	045923809354

** For minimum compartment size of enclosed fixture visit www.satco.com. Lamp life may vary depending on application and use.

Product sheet SA2308

**See warranty for details.

Hi-Pro LED 12-24V low voltage lamps

Low voltage, high lumen,
omni-directional lamps
for industrial and
commercial applications

Replaces HID, CFL, and Incandescent
Approved for totally enclosed fixtures**
IP65 rated
5000K
Long life—50,000 hours
5 Year limited warranty



S9753

S9754

S9755



High Lumen Industrial/Commercial LED Lamps - 12-24V

Item Number	Lamp Description	Replaces INC/HID	W	V	Base Type	CCT	Lm	M.O.L. (Inches)	Life/ Hrs.	UPC	Pack
S9753	10W/LED/HID/5000K/12V-24V E26	90/30	10	12-24	E26	5000K	1200	5 13/16	50K	045923097539	48
S9754	14W/LED/HID/5000K/12V-24V E26	150/50	14	12-24	E26	5000K	1680	6 3/16	50K	045923097546	48
S9755	18W/LED/HID/5000K/12V-24V E26	200/70	18	12-24	E26	5000K	2160	7	50K	045923097553	48

** For minimum compartment size of enclosed fixture visit www.satco.com. Lamp life may vary depending on application and use.

Product sheet SA2609

Hi-Pro LED post top lamps

For use in any post top fixture to provide light
out and down only
Direct wire (ballast by-pass) 100-277V / E26
Approved for enclosed fixtures**
Long life—50,000 hours
5 Year limited warranty

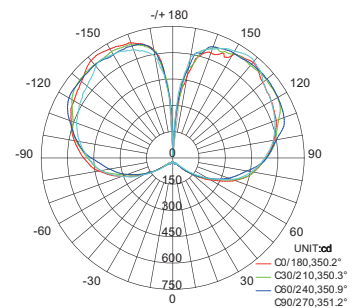

Controls
light pollution



High Lumen LED Lamps

Item Number	Lamp Description	W	V	Base Type	CRI	CCT	Lm	M.O.L. (Inches)	Life/ Hrs.	UPC	Pack/ Mstr.
S9779	40W/LED/HID/PT/3000K/100-277V	40	100-277	E26	80+	3000K	5000	5 1/2	50K	045923097799	12

Accessories

92-410	Mog to Med Socket Reducer									045923924064	
80-929	Hard Wire Surge Protector									045923809293	

Product sheet SA2107

**See warranty for details.

Third generation Hi-Pro LED multi-beam lamps

High lumen, adjustable,
multi-directional lamps
for industrial and
commercial applications

- Replaces HID, CFL, and incandescent
- Direct wire range voltage 100-277V
- Approved for totally enclosed fixtures**
- High bay, low bay, hanging sockets,
and post top
- 2700K or 5000K
- Light panels lock into place creating
- 3 separate beam angle options
- Long life—50,000 hours
- 5 Year limited warranty



260° Beam



150° Beam



120° Beam

HI-PRO HID REPLACEMENTS

High Lumen Multi-Beam Industrial/Commercial LED Lamps



Item Number	Lamp Description	INC/CFL/HID	W	V	Base Type	CCT	Lm	M.O.L. (Inches)	Life/Hrs.	UPC	Pack/Mstr.	
S39768	30W/LED/HID/MB/ 27K/100-277V/E26	200/55/150	30	100-277	E26	2700K	3840	6¾	50K	045923397684	24	
S39750	30W/LED/HID/MB/ 5K/100-277V/E26	200/55/150	30	100-277	E26	5000K	4200	6¾	50K	045923397509	24	
S39798	40W/LED/HID/MB /27K/100-277V/EX39	300/65/175	40	100-277	EX39	2700K	5120	7¼	50K	045923397981	12	
S39751	40W/LED/HID/MB/ 5K/100-277V/EX39	300/65/175	40	100-277	EX39	5000K	5600	7¼	50K	045923397516	12	
S39799	60W/LED/HID/MB/ 27K/100-277V/EX39	500/85/250	60	100-277	EX39	2700K	7680	7¾	50K	045923397998	12	
S39752	60W/LED/HID/MB/ 5K/100-277V/EX39	500/85/250	60	100-277	EX39	5000K	8400	7¾	50K	045923397523	12	
S39769	75W/LED/HID/MB/ 5K/100-277V/EX39	750/105/400	75	100-277	EX39	5000K	10500	8½	50K	045923397691	12	
S39679	90W/LED/HID/MB/ 5K/100-277V/EX39	750/150/600	90	100-277	EX39	5000K	12600	10	50K	045923396793	6	
Accessories												
86-215	Hi-Pro Motion Sensor/PIR (Passive Infrared)										045923862151	
80-929	Hard Wire Surge Protector - 10kV										045923809293	
92-410	Mog to Med Socket Reducer for S39750 and S39768										045923924101	

Product sheet SA2678

**See warranty for details.



270° Beam

60W LED multi-beam Utility light with and without motion sensor

Applications

- Garage
- Barn
- Workshop
- Shed
- Utility room
- Large open spaces

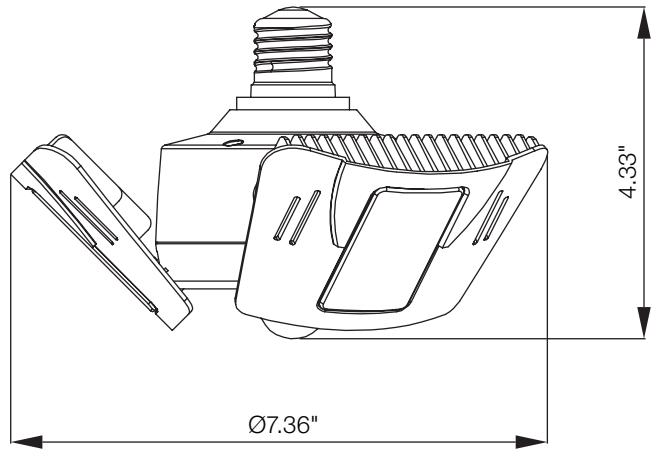

Features

- Replaces high-wattage HID CFL and Incandescent lamps, but uses only 60 Watts
- LED panels adjust to 135° and a full 180°
- Rugged construction
- Built-in motion sensor option
- E26 medium base
- Direct wire range voltage 100-277V
- Damp location
- cULus Listed
- 3 Year warranty



120° Beam

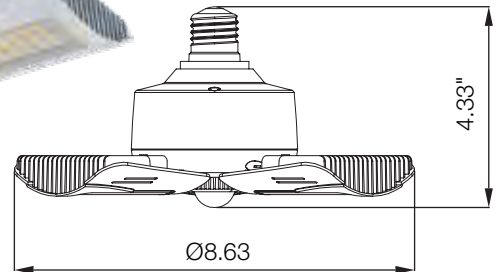

60W LED multi-beam Utility light with and without motion sensor



Item Number	Lamp Description	W	V	CRI	Bulb Type	Base Type	CCT	Finish	Lm	Life/Hrs	UPC	Pack/Master
S13118	60W/LED/UTL/MB/4000K	60	100-277	80	MULTI-BEAM	E26	4000K	White	5880	50K	045923131189	12
S13119	60W/LED/UTL/MB/4000K/MOTION	60	100-277	80	MULTI-BEAM	E26	4000K	White	5880	50K	045923131196	12

Product sheet SA2320

See warranty for details.

High Voltage Hi-Pro LED Lamps 277V-480V

Features

- High Lumen Omni-directional LED for Industrial/ Commercial applications
- Direct wire range voltage 277-480V
- Approved for totally enclosed fixtures**
- 4KV Surge protection



HI-PRO HID REPLACEMENTS

High Voltage Hi-Pro LED LAMPS 277V-480V



Item Number	Lamp Description	W	HID Equiv	V	CRI	CCT	Base Type	Lumens	Life/Hrs.	UPC	Pack
S13123	54W/LED/HID/5K/277-480V/EX39	54	250W	277-480V	80	5000K	EX39	8100	50K	045923131233	12
S13124	100W/LED/HID/5K/277-480V/EX39	100	400W	277-480V	80	5000K	EX39	15000	50K	045923131240	4

Product sheet SA2698

**See warranty for details.

Hi-Pro 360

Innovation in every direction—literally!
Rotating, multi-angle LED lamp

Applications

- Indoor/outdoor direct replacement
- Street lamps/shoe box
- High bays/low bays
- Parking garages
- Commercial and industrial security
- Gymnasiums and other high ceiling applications
- Outdoor canopies

Features

- Multi-angle rotating LED lamp with folding panel design
- Replaces HID, CFL, and incandescent
- Direct wire range voltage 100-277V
- Approved for totally enclosed fixtures
- 70 Watts
- 2700K 4000K or 5000K options
- Built-in 4K surge protection
- EX39 base
- IP64/Damp location
- Long life—50,000 hours
- 5 Year limited warranty

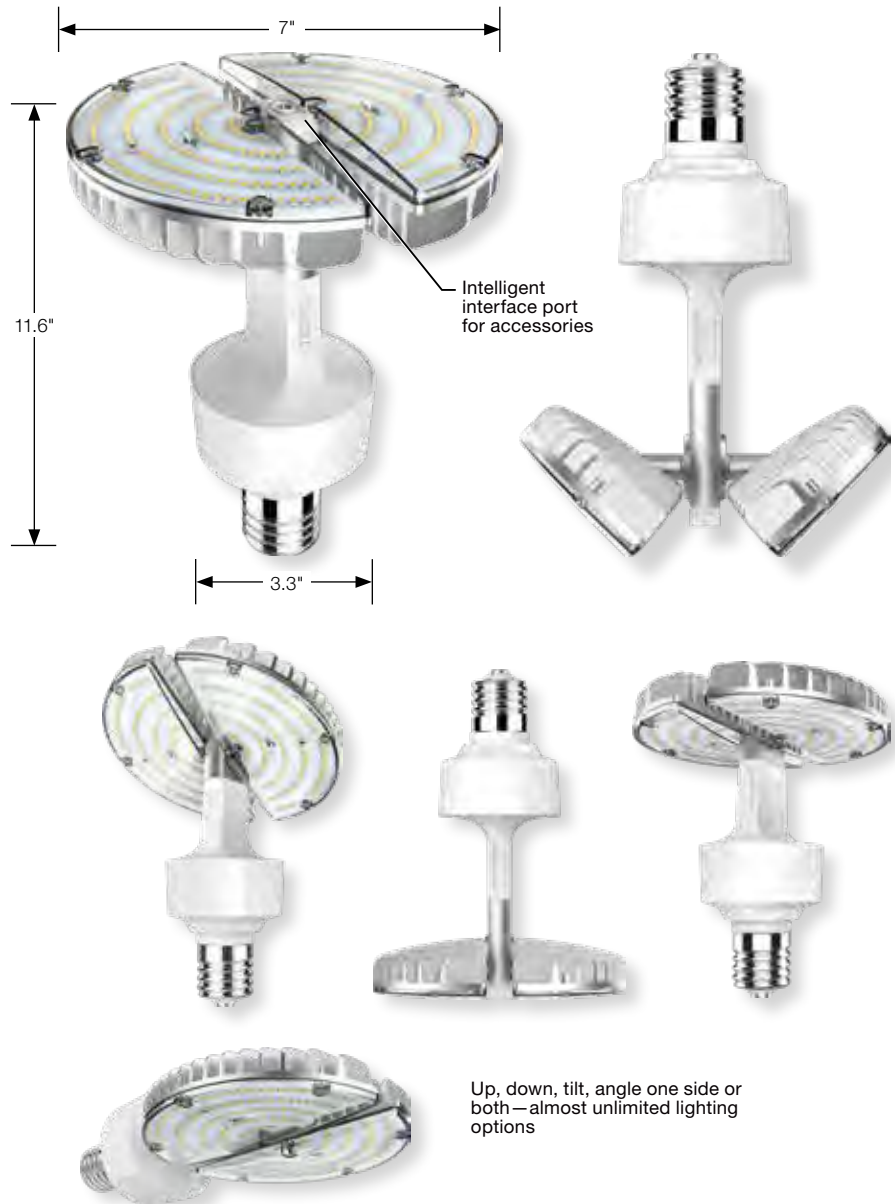

Up, down, tilt, angle one side or both—almost unlimited lighting options

Hi-Pro 360 Lamps



Item Number	Lamp Description	W	V	Base Type	CRI	CCT	Lm	M.O.L. (Inches)	Life/Hrs.	UPC	Pack/Mstr.
S13120*	70W/LED/HP360/827	70	100-277	EX39	80+	2700K	10500	11 1/16	50K	045923131202	8
S13121*	70W/LED/HP360/840	70	100-277	EX39	80+	4000K	10500	11 1/16	50K	045923131219	8
S13122*	70W/LED/HP360/850	70	100-277	EX39	80+	5000K	10500	11 1/16	50K	045923131226	8

Accessories

80-929	Hard Wire Surge Protector – 10kV									045923809293	
80-954	Hi-Pro Wi-Fi Module – (Satco STARFISH in the App store)									045923809549	
80-956	Hi-Pro Photocell - On/Off with adjustable settings for daylight and timers									045923809563	
80-957	Hi-Pro Microwave motion sensor - On/Off with standby dimming option									045923809570	

† Dimmable via WiFi accessory only.

**See warranty for details.

GEN2 Hi-Pro shoebox lamp with smart port

Applications

- Shoebox/Parking lot
- Canopy
- Landscape Flood

Features

- Greater efficiency
- 4Kv surge protection
- Advanced heat dissipation
- Rotatable base
- New smart sensor port & accessories



HI-PRO HID REPLACEMENTS



Item Number	Lamp Description	W	V	Base Type	CCT	Lm	Bm	M.O.L. (Inches)	Life/Hrs.	UPC	Pack
High Lumen Industrial/Commercial LED Lamps											
S28931	80W/LED/HID/SB/3K/EX39/100-277V	80	100-277V	EX39	3000K	10,400	180°	8 ¾	50K	045923289316	4
S28932	80W/LED/HID/SB/5K/EX39/100-277V	80	100-277V	EX39	5000K	10,400	180°	8 ¾	50K	045923289323	4
S28937	110W/LED/HID/SB/3K/EX39/100-277V	110	100-277V	EX39	3000K	14,300	180°	11 ¼	50K	045923289378	4
S28938	110W/LED/HID/SB/5K/EX39/100-277V	110	100-277V	EX39	5000K	14,300	180°	11 ¼	50K	045923289385	4

Accessories

80-929	Hard Wire Surge Protector – 10kV									045923809293	
80-954	Hi-Pro Wi-Fi Module – (Satco STARFISH in the App store)									045923809549	
80-956	Hi-Pro Photocell - On/Off with adjustable settings for daylight and timers									045923809563	
80-957	Hi-Pro Microwave motion sensor - On/Off with standby dimming option									045923809570	

** For minimum compartment size of enclosed fixture visit www.satco.com. Lamp life may vary depending on application and use.

Product sheet SA2687

**See warranty for details.

Hi-Pro LED wall pack lamp series

High lumen, directional
lamps for industrial and
commercial fixture applications

For use in wall pack, canopy, shoe box,
or cobra head fixtures

20/30/40/60 Watt options replaces
100/150/175/250 Watt HID

Replaces HID

Approved for totally enclosed fixtures**

Direct wire range voltage 100-277V

IP64, higher efficiency, improved
heat dissipation

4KV Surge protection

Reduced size

180° beam/adjustable base (E26/E39)

Horizontal operation

DLC listed*

Damp location

Long life—50,000 hours

5 Year limited warranty

320° Swivel
when installed

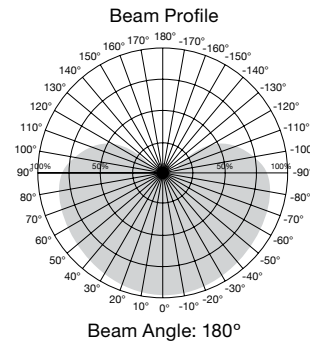

High Lumen Industrial/Commercial LED Lamps



**



Item Number	Lamp Description	W	V	Rpl.	Base Type	CCT	Lm	Bm	M.O.L. (Inches)	Life/Hrs.	UPC	Pack
S8928	20W/LED/HID/WP/5K/E26/100-277V	20	100-277	100W	E26	5000K	3000	180°	5 ¼	50K	045923089282	12
S8980	30W/LED/HID/WP/5K/E26/100-277V	30	100-277	150W	E26	5000K	4500	180°	7	50K	045923089800	12
S8929	40W/LED/HID/WP/5K/E26/100-277V	40	100-277	175W	E26	5000K	6000	180°	7 7/8	50K	045923089299	12
S8930*	40W/LED/HID/WP/5K/E39/100-277V	40	100-277	175W	E39	5000K	6000	180°	8 ½	50K	045923089305	12
S8987*	60W/LED/HID/WP/5K/E39/100-277V	60	100-277	250W	E39	5000K	9000	180°	10 ¾	50K	045923089879	12

Accessories

92-410	Mog to Med Socket Reducer for S9750										045923924064	
80-929	Hard Wire Surge Protector										045923809293	

** For minimum compartment size of enclosed fixture visit www.satco.com. Lamp life may vary depending on application and use.

Product sheet SA2173

**See warranty for details.

Hi-Pro LED high bay/low bay lamps

High lumen LED lamps for industrial and commercial applications

Features

- Replaces HID, CFL, and Incandescent
- 115° beam angle
- Long neck option fits more fixtures
- Direct wire range voltage 120-277V
- 6 KV Surge protection
- Light weight
- Advanced passive heat dissipation
- Long life—50,000 hours
- 5 Year limited warranty

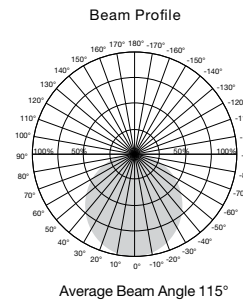
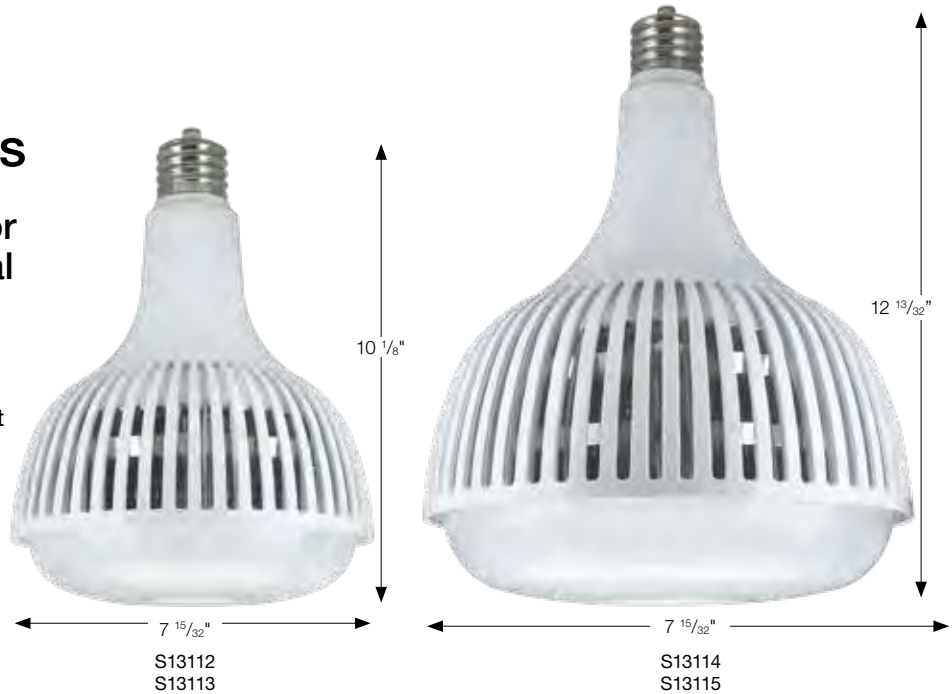

High Lumen Industrial/Commercial LED Lamps



Item Number	Lamp Description	W	V	Base Type	CRI	CCT	Lm	Bm	M.O.L. (Inches)	Life/Hrs.	UPC	Pack
S13112*	80W/LED/HID-HB/4K/120-277V	80	120-277	EX39	80+	4000K	9300	115	10 1/8	50K	045923131127	4
S13113*	80W/LED/HID-HB/5K/120-277V	80	120-277	EX39	80+	5000K	9700	115	10 1/8	50K	045923131134	4
S13114*	130W/LED/HID-HB/4K/120-277V	130	120-277	EX39	80+	4000K	15500	115	12 3/8	50K	045923131141	4
S13115*	130W/LED/HID-HB/5K/120-277V	130	120-277	EX39	80+	5000K	16100	115	12 3/8	50K	045923131158	4

Accessories

80-929 Hard Wire Surge Protector 045923809293

** For minimum compartment size of enclosed fixture visit www.satco.com. Lamp life may vary depending on application and use.

Product sheet SA2530

**See warranty for details.

Hi-Pro Sensors

Adjustable controls for LED HID replacement lamps

Even more energy saving • Increased functionality • Simple installation (plug and play)

80-954 Hi-Pro WiFi Module

Features

- Access functions through Satco/Starfish App
- Dimming and time control
- Support single or group lamp control
- Available voice control: Amazon Echo, Google Home, etc.
- WiFi: 2.4GHz
- OS: Android 4.2 or newer, IOS 8.0 or newer



80-954

Specifications

- Operating voltage: 15V DC + 2V
- Current: 20mA
- IP rating: IP20
- WiFi: 2.4GHz
- OS: Android 4.2 or newer, IOS 8.0 or newer
- Operating Temperature: -20°C (+4°F) to +60°C (+140°F)
- Warranty: 5 years

80-956 Hi-Pro Photocell

Features

- Natural light detection
- Reaction lux options: 20 lx, 50 lx, 100 lx, 300 lx
- Adjustable hold time
- Standard 3.5mm Aux port connection



80-956

Specifications

- Operating voltage: 15V DC + 2V
- Output voltage: 0-10V
- Current: 20mA
- IP rating: IP20
- Operating Temperature: -20°C (4°F) to +60°C (+140°F)
- Warranty: 5 years

80-955 Hi-Pro Motion Sensor / Infra-Red

Features

- Motion detection area: 6m (19.7')
- Standby bi-level dimming: Off, 20% dim, 40% dim or 60% dim
- Hold time: up to 10 minutes
- Standard 3.5mm Aux port connection
- Not for use in enclosed fixtures



80-955

Specifications

- Operating voltage: 15V DC + 2V
- Output voltage: 0-10V
- Current: 20mA
- IP rating: IP20
- Operating Temperature: -20°C (+4°F) to +35°C (+95°F)
- Warranty: 5 years

80-957 Hi-Pro Motion Sensor / Microwave

Features

- Motion detection area: 10m (33')
- Standby bi-level dimming: Off, 20% dim, 40% dim or 60% dim
- Hold time: up to 10 minutes
- Suitable for use in enclosed fixtures (non-metallic)



80-957

Specifications

- Operating voltage: 15V DC + 2V
- Output voltage: 0-10V
- Current: 20mA
- IP rating: IP20
- Operating Temperature: -20°C (+4°F) to +60°C (+140°F)
- Warranty: 5 years

For Use with: Hi-Pro 360 (page 74), Shoebox Series (page 75)

Item Number	Description	UPC
80-954	Hi-Pro Wi-Fi Module – (Satco STARFISH in the App store)	045923809549
80-955	Hi-Pro Motion Sensor - Infra-Red - Standby bi-level dimming	045923809552
80-956	Hi-Pro Photocell - On/Off with adjustable settings for daylight and timers	045923809563
80-957	Hi-Pro Microwave motion sensor - On/Off with standby dimming option	045923809570

Product sheet SA2634

See warranty for details.



E39 Mogul Base

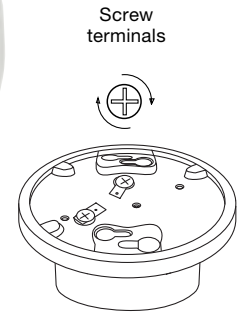

Screw terminals



HI-PRO HID REPLACEMENTS

Instant hi-bay fixture Keyless porcelain mogul base lamp holder with screw terminals

- Perfect for use with LED HID replacement lamps
- Commercial/industrial applications
- Screw-in eye hook for safety cable included
- Holder rated at 1500W Max.
- 600V
- Max lamp weight 5 lbs.



Lamp and cables not included

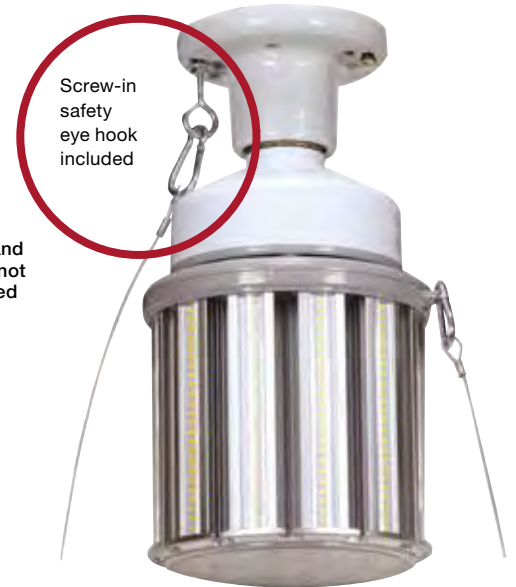

Screw-in safety eye hook included

Keyless Porcelain Mogul Base Lamp Holder



Item Number	Lamp Description	Max. W	Max. V	UPC	Pack
90-483	Keyless Mogul Lamp Holder	1500	600	045923904837	40

Product sheet SA2393

See warranty for details.

Hi-Pro LED temporary work lights

New Work Light Series: Built to Work on the Job Longer, Harder, Brighter than ever!

- Durable, lightweight with high impact cage
- Energy-efficient, high lumen led lighting
- Omni-directional 360° beam angle
- Grounded 3-prong plug
- T-handle for mounting

Linkable for longer runs from one power supply.



600W max linked units:
 60W x 10 pcs. max
 100W x 6 pcs. max
 150W x 4 pcs. max

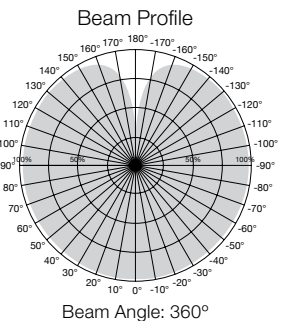
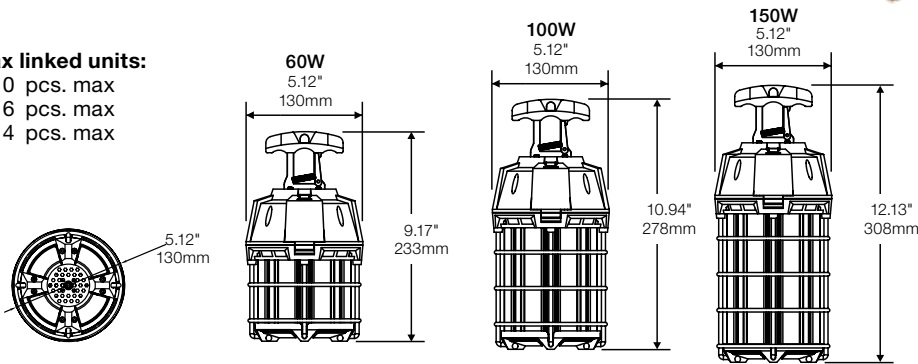

Hi-Pro LED Temporary Work Lights



Item Number	Lamp Description	W	V	CRI	CCT	Base Type	Lm	Life/Hrs.	UPC	Pack
S38939	60W/LED/HID/TEMP/5K/120V	60	120V	85	5000K	Hook/Plug	6000	50K	045923389399	4
S38946	100W/LED/HID/TEMP/5K/120V	100	120V	85	5000K	Hook/Plug	10000	50K	045923389467	4
S38975	150W/LED/HID/TEMP/5K/120V	150	120V	85	5000K	Hook/Plug	15000	50K	045923389757	4

Product sheet SA2703

See warranty for details.

Hi-Pro temporary construction string light set - 50 ft.

Features

For use in any commercial work area

5 Lights per string

50 Watt/6000 Lumens per string

10 ft. between lights

Linkable up to 6 sets

Replaces HID, CFL and Incandescent

360° Omni-directional light

Portable/plug-in, 120V

IP65—Water and dust proof

18 AWG cable



HI-PRO HID REPLACEMENTS

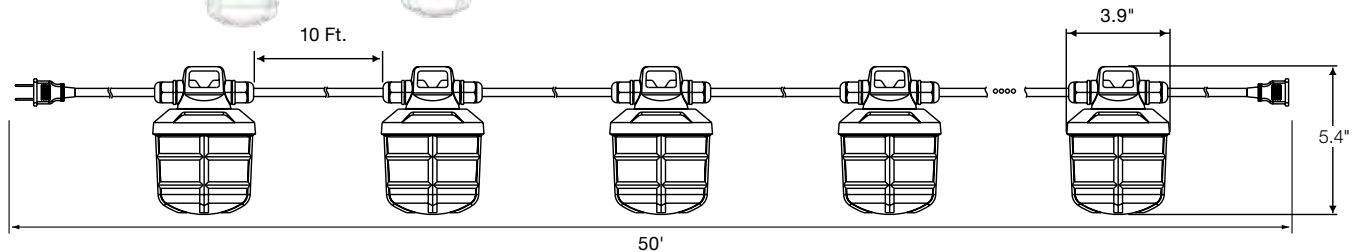

5 x 10W Lamps

Replace

5 x 75W Lamps

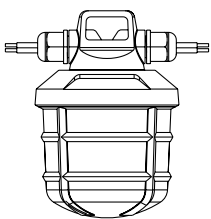

Total 50W

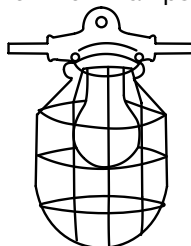

Total 375W

Beam Profile/Lamp

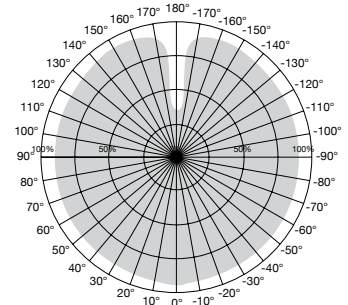

360° Illumination

Hi-Pro Temporary Construction String Light Set - 50 Ft.



Item Number	Lamp Description	W	V	CRI	CCT	Base Type	Lm	Life/Hrs.	UPC	Pack
S28976	50W/LED/5PC/TEMP/STRING/120V	100	120	85	5000K	2 Prong Plug	10000	50K	045923289767	4

Product sheet SA2716

See warranty for details.



LED/CFL ballast bypass Type B replacement lamps 2-Pin G23, GX23 base

Applications / Features

- 4.5W G23 replaces 5W, 7W & 9W CFL
- 6W GX23 replaces 13W CFL
- 2-Sided illumination
- Instant on to full brightness / no flickering
- Vertical or horizontal applications
- Up to 50% energy saving
- c-UL-us Classified
- Long life—50,000 hours
- 5 Year warranty

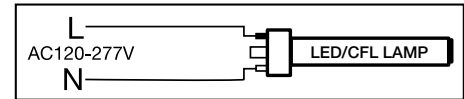

Wiring diagram



S18400-S18404 G23 Base



S28725-S28729 GX23 Base

LED/CFL Ballast Bypass Type B Replacement Lamps



Item Number	Description	W	V	Base Type	CCT	CRI	Beam	M.O.L. (Inches)	LM	Life/ Hrs.	UPC	Pack/ Master
S18400	4.5W/LED/CFL/827/G23/BP	4.5	120-277	G23	2700K	80	360°	6 ½	450	50K	045923184000	50
S18401	4.5W/LED/CFL/830/G23/BP	4.5	120-277	G23	3000K	80	360°	6 ½	450	50K	045923184017	50
S18402	4.5W/LED/CFL/835/G23/BP	4.5	120-277	G23	3500K	80	360°	6 ½	450	50K	045923184024	50
S18403	4.5W/LED/CFL/840/G23/BP	4.5	120-277	G23	4000K	80	360°	6 ½	450	50K	045923184031	50
S18404	4.5W/LED/CFL/850/G23/BP	4.5	120-277	G23	5000K	80	360°	6 ½	450	50K	045923184048	50
S28725	6W/LED/CFL/827/GX23/BP/G2	6	120-277	GX23	2700K	80	360°	7 ½	600	50K	045923287251	50
S28726	6W/LED/CFL/830/GX23/BP/G2	6	120-277	GX23	3000K	80	360°	7 ½	600	50K	045923287268	50
S28727	6W/LED/CFL/835/GX23/BP/G2	6	120-277	GX23	3500K	80	360°	7 ½	600	50K	045923287275	50
S28728	6W/LED/CFL/840/GX23/BP/G2	6	120-277	GX23	4000K	80	360°	7 ½	600	50K	045923287282	50
S28729	6W/LED/CFL/850/GX23/BP/G2	6	120-277	GX23	5000K	80	360°	7 ½	600	50K	045923287299	50

Product sheet SA2685

See warranty for details.



LED/CFL dual mode (ballast bypass type B/ ballast compatible type A) lamps

Direct replacements for CFL GX23
base lamps in existing fixtures with or
without ballasts.*

Features

- Over 50% energy savings vs. standard
- Ballast compatible and ballast bypass in one lamp
- Instant-on full brightness / no flickering
- 120-277V in bypass mode
- Damp location
- Long life—50,000 hours
- c-UL-us Listed - Type A
- c-UL-us Classified - Type B
- 5 Year warranty**

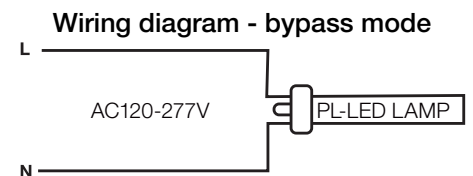
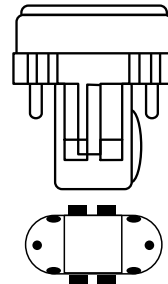

CFL & LINEAR FL REPLACEMENTS

LED/CFL GX23 Base Dual Mode Lamps



Item Number	Lamp Description	W	V (Bypass)	Base Type	CRI	CCT	Lm	Bm	M.O.L. (Inches)	Life/Hrs.	UPC	Pack/Mstr.
S11550	5.5W/LED/CFL/827/2P/DUAL	5.5	120/277	GX23	80	2700K	500	120°	6	50K	045923115509	25
S11551	5.5W/LED/CFL/830/2P/DUAL	5.5	120/277	GX23	80	3000K	500	120°	6	50K	045923115516	25
S11552	5.5W/LED/CFL/835/2P/DUAL	5.5	120/277	GX23	80	3500K	500	120°	6	50K	045923115523	25
S11553	5.5W/LED/CFL/840/2P/DUAL	5.5	120/277	GX23	80	4000K	550	120°	6	50K	045923115530	25
S11554	5.5W/LED/CFL/850/2P/DUAL	5.5	120/277	GX23	80	5000K	550	120°	6	50K	045923115547	25

* Visit www.satco.com for an approved list.

Product sheet SA2668

See warranty for details.

LED/CFL type A direct replacement lamps

4-pin (electronic ballasts)
2-pin (magnetic ballasts)

- 4-pin 26, 32, 42 Watt direct replacement
- 2-pin 26 Watt direct replacement
- 4-pin lamps fit G24q-3 & GX24q-3 and GX24q-4 sockets
- 2-pin lamps fit G24d-3 sockets
- No re-wiring needed
- Instant on to full brightness / no flickering
- Vertical and horizontal options
- Up to 70% energy saving
- DLC listed* (4-pin only)
- c-UL-us listed
- Long life—50,000 hours
- 5 Year warranty



S29858, S29859, S29860, S29861
G24Q



S9862, S9863, S9864, S9865
G24D

Rotates 270° when installed



S29850, S29851, S29852, S29853
G24Q



S9854, S9855, S9856, S9857
G24D

LED/CFL Replacement Lamps



Item Number	Lamp Description	W	Base Type	CCT	CRI	M.O.L. (Inches)	Lm	Life/Hrs.	UPC	Pack/Master
4-Pin Horizontal										
S29850*	9WPLH/LED/830/DR/4P	9	G24Q	3000K	82	6 5/8	950	50K	045923298509	50/10
S29851*	9WPLH/LED/835/DR/4P	9	G24Q	3500K	82	6 5/8	950	50K	045923298516	50/10
S29852*	9WPLH/LED/840/DR/4P	9	G24Q	4000K	82	6 5/8	900	50K	045923098529	50/10
S29853*	9WPLH/LED/850/DR/4P	9	G24Q	5000K	82	6 5/8	900	50K	045923298530	50/10
2-Pin Horizontal										
S9854	9WPLH/LED/830/DR/2P	9	G24D	3000K	82	6 5/8	850	50K	045923098543	50/10
S9855	9WPLH/LED/835/DR/2P	9	G24D	3500K	82	6 5/8	850	50K	045923098550	50/10
S9856	9WPLH/LED/840/DR/2P	9	G24D	4000K	82	6 5/8	900	50K	045923098567	50/10
S9857	9WPLH/LED/850/DR/2P	9	G24D	5000K	82	6 5/8	900	50K	045923098574	50/10
4-Pin Vertical										
S29858*	9WPLV/LED/830/DR/4P	9	G24Q	3000K	82	4 1/16	950	50K	045923298585	50/10
S29859*	9WPLV/LED/835/DR/4P	9	G24Q	3500K	82	4 1/16	950	50K	045923298592	50/10
S29860*	9WPLV/LED/840/DR/4P	9	G24Q	4000K	82	4 1/16	900	50K	045923298608	50/10
S29861*	9WPLV/LED/850/DR/4P	9	G24Q	5000K	82	4 1/16	900	50K	045923298615	50/10
2-Pin Vertical										
S9862	9WPLV/LED/830/DR/2P	9	G24D	3000K	82	4 1/16	850	50K	045923098628	50/10
S9863	9WPLV/LED/835/DR/2P	9	G24D	3500K	82	4 1/16	850	50K	045923098635	50/10
S9864	9WPLV/LED/840/DR/2P	9	G24D	4000K	82	4 1/16	900	50K	045923098642	50/10
S9865	9WPLV/LED/850/DR/2P	9	G24D	5000K	82	4 1/16	900	50K	045923098659	50/10

Product sheet SA1979

See warranty for details.

PL/LED ballast bypass type B replacement lamps

UL Classified

2-pin replacement for up to 26 Watt pin based CFL, uses only 9 Watts

2-pin LED lamps works in both 2-pin (magnetic) and 4-pin (electronic) sockets

- G24d (2-pin)—18 and 26W rep.

- G24q (4-pin)—13, 18, and 26 rep.

Direct wire 120-277V

Instant on to full brightness / no flickering

Rotates up to 270° for various fixture applications

Vertical and horizontal options

Up to 70% energy saving

Damp location

Long life—50,000 hours

5 Year warranty



S8530, S8531, S8532, S8533, S8534



S8535, S8536, S8537,
S8538, S8539

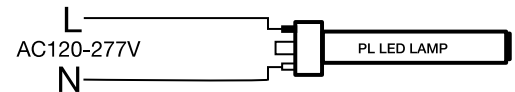
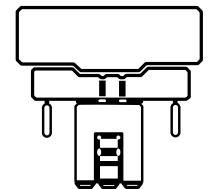
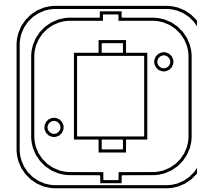

CFL & LINEAR FL REPLACEMENTS



PL/LED Replacement Lamps

Item Number	Lamp Description	W	Base Type	CCT	CRI	M.O.L. (Inches)	Lm	Life/Hrs.	UPC	Pack/Master
S8530	9WPLH/LED/827/BP/2P	9	G24d	2700K	82	6 5/8	900	50K	045923085307	50/10
S8531	9WPLH/LED/830/BP/2P	9	G24d	3000K	82	6 5/8	950	50K	045923085314	50/10
S8532	9WPLH/LED/835/BP/2P	9	G24d	3500K	82	6 5/8	950	50K	045923085321	50/10
S8533	9WPLH/LED/840/BP/2P	9	G24d	4000K	82	6 5/8	1000	50K	045923085338	50/10
S8534	9WPLH/LED/850/BP/2P	9	G24d	5000K	82	6 5/8	1000	50K	045923085345	50/10
S8535	9WPLV/LED/827/BP/2P	9	G24d	2700K	82	4 1/16	900	50K	045923085352	50/10
S8536	9WPLV/LED/830/BP/2P	9	G24d	3000K	82	4 1/16	950	50K	045923085369	50/10
S8537	9WPLV/LED/835/BP/2P	9	G24d	3500K	82	4 1/16	950	50K	045923085376	50/10
S8538	9WPLV/LED/840/BP/2P	9	G24d	4000K	82	4 1/16	1000	50K	045923085383	50/10
S8539	9WPLV/LED/850/BP/2P	9	G24d	5000K	82	4 1/16	1000	50K	045923085390	50/10

Product sheet SA2328

See warranty for details.

LED/CFL type A direct replacement lamps 4-pin (electronic ballasts)

- UL listed 4-pin 42 Watt direct replacement
- 4-pin lamps fit GX24q-4 sockets
- No re-wiring needed
- Instant on to full brightness / no flickering
- Vertical and horizontal options
- DLC Listed*
- c-UL-us listed
- Up to 60% energy saving
- Long life—50,000 hours
- 5 Year warranty

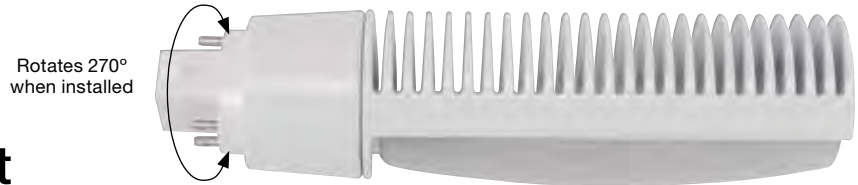

Rotates 270°
when installed

S21400, S21401, S21402, S21403



S21404, S21405, S21406, S21407

LED/CFL Replacement Lamps - Ballast Compatible♦



Item Number	Lamp Description	W	Base Type	CCT	CRI	M.O.L. (Inches)	Lm	Life/ Hrs.	UPC	Pack/ Mstr.
S21400*	PLT/16W/H/LED/830/4P/DR	16	G24Q	3000K	82	6 3/8	1750	50K	045923224003	20
S21401*	PLT/16W/H/LED/835/4P/DR	16	G24Q	3500K	82	6 3/8	1750	50K	045923224010	20
S21402*	PLT/16W/H/LED/840/4P/DR	16	G24Q	4000K	82	6 3/8	1850	50K	045923224027	20
S21403*	PLT/16W/H/LED/850/4P/DR	16	G24Q	5000K	82	6 3/8	1850	50K	045923224034	20
S21404*	PLT/16W/V/LED/830/4P/DR	16	G24Q	3000K	82	5 3/4	1750	50K	045923224041	20
S21405*	PLT/16W/V/LED/835/4P/DR	16	G24Q	3500K	82	5 3/4	1750	50K	045923224058	20
S21406*	PLT/16W/V/LED/840/4P/DR	16	G24Q	4000K	82	5 3/4	1850	50K	045923224065	20
S21407*	PLT/16W/V/LED/850/4P/DR	16	G24Q	5000K	82	5 3/4	1850	50K	045923224072	20

♦ Visit www.satco.com for ballast compatibility list.

Product sheet SA2471

See warranty for details.

LED/CFL ballast bypass type B replacement lamps

2-Pin GX23 ballast bypass GU24 Base, E26 Base

- 2-Pin 13 Watt CFL direct replacement
- GU24 Base and E26 Base are 13-18 Watt CFL and 60 Watt Incandescent direct replacements
- Instant on to full brightness / no flickering
- Rotates up to 270° for various fixture applications
- Vertical and horizontal options
- Up to 70% energy saving
- c-UL-us Classified—2-Pin ballast bypass
- c-UL-us listed—GU24 base, E26 base
- Long life—50,000 hours
- 5 Year warranty



GU24
S8745, S8746, S8747, S4748, S8749

E26
S8755, S8756, S8757, S4758, S8759



LED/CFL Replacement Lamps

Item Number	Lamp Description	W	V	Base Type	CCT	CRI	M.O.L. (Inches)	Lm	Life/Hrs.	UPC	Pack/Master
GU24 Base—c-UL-us listed											
S8745	8W/H/LED/CFL/827/GU24	8	120-277V	GU24	2700K	83	6 1/2	920	50K	045923087455	50/10
S8746	8W/H/LED/CFL/830/GU24	8	120-277V	GU24	3000K	83	6 1/2	920	50K	045923087462	50/10
S8747	8W/H/LED/CFL/835/GU24	8	120-277V	GU24	3500K	83	6 1/2	960	50K	045923087479	50/10
S8748	8W/H/LED/CFL/840/GU24	8	120-277V	GU24	4000K	83	6 1/2	960	50K	045923087486	50/10
S8749	8W/H/LED/CFL/850/GU24	8	120-277V	GU24	5000K	83	6 1/2	960	50K	045923087493	50/10
E26 Base—c-UL-us listed											
S8755	8W/H/LED/CFL/827/E26	8	120-277V	E26	2700K	83	6 13/16	920	50K	045923087554	50/10
S8756	8W/H/LED/CFL/830/E26	8	120-277V	E26	3000K	83	6 13/16	920	50K	045923087561	50/10
S8757	8W/H/LED/CFL/835/E26	8	120-277V	E26	3500K	83	6 13/16	960	50K	045923087578	50/10
S8758	8W/H/LED/CFL/840/E26	8	120-277V	E26	4000K	83	6 13/16	960	50K	045923087585	50/10
S8759	8W/H/LED/CFL/850/E26	8	120-277V	E26	5000K	83	6 13/16	960	50K	045923087592	50/10

Product sheet SA2119

See warranty for details.

2G11 PLL 36W & 40W type B replacement lamps

Ballast bypass replacement for 4-pin 40W PL-L

- Direct wire 120-277V
- All glass tube
- Over 40% energy savings
- Instant on to full brightness/no flickering
- c-UL-us classified
- Long life—50,000 hours
- 5 Year warranty

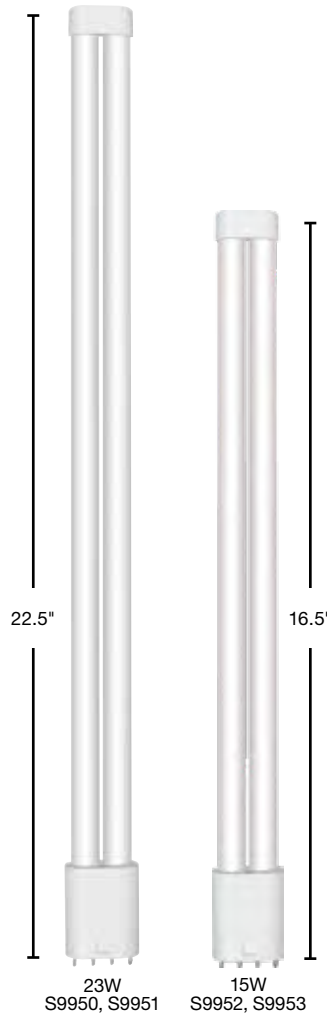

Wiring diagram

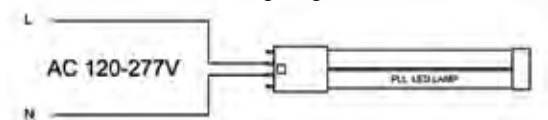

Satco 2G11 36W & 40W LED/CFL Replacement Lamps

Item Number	Lamp Description	W	CRI	Base Type	CCT	Lm	M.O.L. (Inches)	Life/ Hrs.	UPC	Pack
S9952	15PLL/LED/835/BP	15	80	2G11	3500K	2000	16 ½	50K	045923099526	10
S9953	15PLL/LED/840/BP	15	80	2G11	4000K	2000	16 ½	50K	045923099533	10
S9950	23PLL/LED/835/BP	23	82	2G11	3500K	2600	22 ½	50K	045923099502	10
S9951	23PLL/LED/840/BP	23	82	2G11	4000K	2800	22 ½	50K	045923099519	10

Product sheet SA2194

See warranty for details.

2', 3' & 6" U-bend LED type A T8 lamps

Direct replacement for linear or U-bend T8 fluorescent lamps in existing fixtures with instant or rapid start ballasts. No rewiring required*

- Over 40% energy savings vs. standard T8 systems
- All glass tube
- Direct replacement solution allows the fixture to maintain the Original UL and CSA Compliance
- Compatible with emergency ballasts (2' & 3')^{††}
- Integrated thermal fuse at pins
- Damp location
- DLC listed*
- NSF certified
- c-UL-us listed
- Long life—50,000 hours
- 5 Year warranty

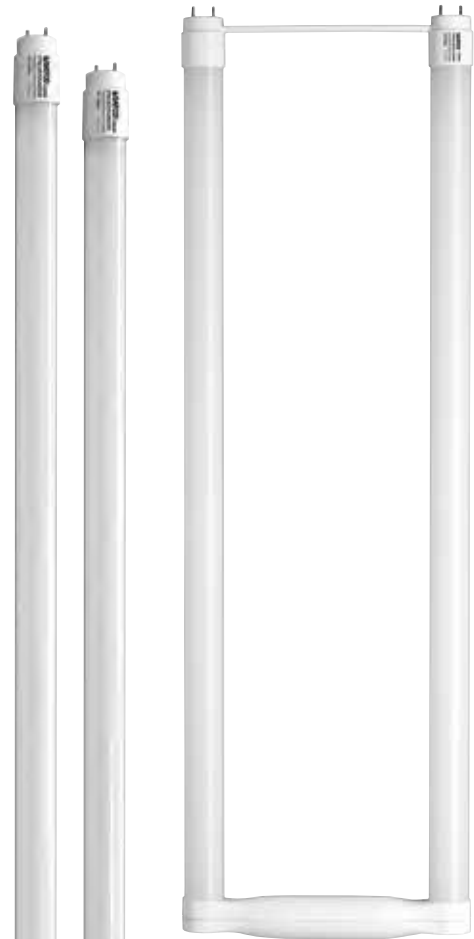

LED T8 2', 3' & 6" U-Bend Ballast Compatible

Item Number	Lamp Description	W	CRI	Base Type	Bm	CCT	Lm	M.O.L. (Inches)	Life/ Hrs.	UPC	Pack
2' LED T8**											
S9946*	8T8/LED/24-830/DR	8	82	Med Bi-Pin	220°	3000K	1200	24	50K	045923099465	10
S9947*	8T8/LED/24-835/DR	8	82	Med Bi-Pin	220°	3500K	1200	24	50K	045923099472	10
S9948*	8T8/LED/24-840/DR	8	82	Med Bi-Pin	220°	4000K	1250	24	50K	045923099489	10
S9949*	8T8/LED/24-850/DR	8	82	Med Bi-Pin	220°	5000K	1250	24	50K	045923099496	10
3' LED T8**											
S29990*	10T8/LED/36-830/DR	10	82	Med Bi-Pin	220°	3000K	1400	36	50K	045923099908	10
S29991*	10T8/LED/36-835/DR	10	82	Med Bi-Pin	220°	3500K	1400	36	50K	045923099915	10
S29992*	10T8/LED/36-840/DR	10	82	Med Bi-Pin	220°	4000K	1450	36	50K	045923099922	10
S29993*	10T8/LED/36-850/DR	10	82	Med Bi-Pin	220°	5000K	1450	36	50K	045923099939	10
U-Bend 6" LED T8											
S9994*	11.5T8U6/LED/22.5-830/DR	11.5	82	Med Bi-Pin	230°	3000K	1700	22 ½	50K	045923099946	12
S9995*	11.5T8U6/LED/22.5-835/DR	11.5	82	Med Bi-Pin	230°	3500K	1700	22 ½	50K	045923099953	12
S9996*	11.5T8U6/LED/22.5-840/DR	11.5	82	Med Bi-Pin	230°	4000K	1800	22 ½	50K	045923099960	12
S9997*	11.5T8U6/LED/22.5-850/DR	11.5	82	Med Bi-Pin	230°	5000K	1800	22 ½	50K	045923099977	12

CFL & LINEAR FL REPLACEMENTS

* May not be compatible with all ballasts. Visit www.satco.com for an approved list.
 ** 2' & 3' May not be compatible with all rapid start and emergency ballasts. Visit www.satco.com for an approved list. Product sheets SA2361, SA2153

See warranty for details.



12W and 15W, 4' LED type A T8 lamps

Direct replacement for linear fluorescent T8 lamps in existing fixtures with instant or rapid start ballasts. No rewiring required*

- Over 40% energy savings vs. standard 4' T8 systems
- All glass tube
- Compatible with emergency & dimming ballasts*
- Integrated thermal fuse at pins
- Damp location
- c-UL-us listed
- NSF certified
- DLC listed*
- Long life—50,000 hours
- 5 Year warranty



LED T8 Ballast Compatible - 12W

Item Number	Lamp Description	W	CRI	Bulb Type	Bm	CCT	Lm	M.O.L. (Inches)	Life/ Hrs.	UPC	Pack
S39934*	12T8/LED/48-830/DR	12	82	T8	210°	3000K	1700	48	50K	045923399343	25
S39935*	12T8/LED/48-835/DR	12	82	T8	210°	3500K	1700	48	50K	045923399350	25
S39936*	12T8/LED/48-840/DR	12	82	T8	210°	4000K	1800	48	50K	045923399367	25
S39937*	12T8/LED/48-850/DR	12	82	T8	210°	5000K	1800	48	50K	045923399374	25

* May not be compatible with all IS, RS, DM, and EM ballasts. Visit www.satco.com for an approved list.

Product sheet SA2305



LED T8 Ballast Compatible - 15W

Item Number	Lamp Description	W	CRI	Bulb Type	Bm	CCT	Lm	M.O.L. (Inches)	Life/ Hrs.	UPC	Pack
S39975*	15T8/LED/48-830/DR	15	80	T8	210°	3000K	2100	48	50K	045923399756	25
S39976*	15T8/LED/48-835/DR	15	80	T8	210°	3500K	2100	48	50K	045923399763	25
S39977*	15T8/LED/48-840/DR	15	80	T8	210°	4000K	2200	48	50K	045923399770	25
S39978*	15T8/LED/48-850/DR	15	80	T8	210°	5000K	2200	48	50K	045923399787	25

* May not be compatible with all IS, RS, DM, and EM ballasts. Visit www.satco.com for an approved list.

Product sheet SA2487

See warranty for details.

Linear LED ballast bypass type B T8 series

Double ended wiring

- Works with existing sockets—shunted or non-shunted
- Reduces labor costs for installation
- Built-in shock resistant circuit (not hot until both ends are installed)
- No ballast or external driver required
- Direct wire 120-277V line voltage
- All glass tube
- Approved for use with tube guards
- Damp location
- c-UL-us Classified
- DLC Listed
- Long life—50,000 hours
- 5 Year warranty



Double Ended Wiring Diagram
AC120-277V

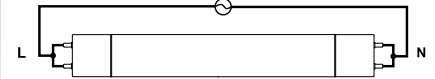

LED T8 Ballast Bypass

Item Number	Lamp Description	W	CRI	Base Type	Bm	CCT	Lm	M.O.L. (Inches)	Life/ Hrs.	UPC	Pack
9W, 2'											
S29900	9T8/LED/24-830/BP 120-277V	9	82	Med Bi-Pin	220°	3000K	1100	24	50K	045923299001	25
S29901	9T8/LED/24-835/BP 120-277V	9	82	Med Bi-Pin	220°	3500K	1100	24	50K	045923299018	25
S29902	9T8/LED/24-840/BP 120-277V	9	82	Med Bi-Pin	220°	4000K	1150	24	50K	045923299025	25
S29903	9T8/LED/24-850/BP 120-277V	9	82	Med Bi-Pin	220°	5000K	1150	24	50K	045923299032	25
12W, 3'											
S29926	12T8/LED/36-830/BP 120-277V	12	82	Med Bi-Pin	220°	3000K	1400	36	50K	045923299261	25
S29927	12T8/LED/36-835/BP 120-277V	12	82	Med Bi-Pin	220°	3500K	1400	36	50K	045923299278	25
S29928	12T8/LED/36-840/BP 120-277V	12	82	Med Bi-Pin	220°	4000K	1450	36	50K	045923299285	25
S29929	12T8/LED/36-850/BP 120-277V	12	82	Med Bi-Pin	220°	5000K	1450	36	50K	045923299292	25
14W, 4'											
S29913	14T8/LED/48-830/BP 120-277V	14	82	Med Bi-Pin	220°	3000K	1800	48	50K	045923299131	25
S29914	14T8/LED/48-835/BP 120-277V	14	82	Med Bi-Pin	220°	3500K	1800	48	50K	045923299148	25
S29915	14T8/LED/48-840/BP 120-277V	14	82	Med Bi-Pin	220°	4000K	1800	48	50K	045923299155	25
S29916	14T8/LED/48-850/BP 120-277V	14	82	Med Bi-Pin	220°	5000K	1800	48	50K	045923299162	25
S11924	14T8/LED/48-865/BP 120-277V	14	82	Med Bi-Pin	210°	6500K	1800	48	50K	045923119248	25
17W, 4'											
S29904	17T8/LED/48-830/BP 120-277V	17	82	Med Bi-Pin	220°	3000K	2100	48	50K	045923299049	25
S29905	17T8/LED/48-835/BP 120-277V	17	82	Med Bi-Pin	220°	3500K	2100	48	50K	045923299056	25
S29906	17T8/LED/48-840/BP 120-277V	17	82	Med Bi-Pin	220°	4000K	2200	48	50K	045923299063	25
S29907	17T8/LED/48-850/BP 120-277V	17	82	Med Bi-Pin	220°	5000K	2200	48	50K	045923299070	25

Product sheet SA2405

See warranty for details.

Dimmable 13.5W linear LED T8 ballast bypass type B lamps

Features

- No ballast or external driver required
- Direct wire 120V line voltage*
- All glass tube
- Dimmable**
- Damp location
- Long life: 50,000 hours
- c-UL-us Classified
- DLC Listed
- NSF Certified
- 5 Year warranty

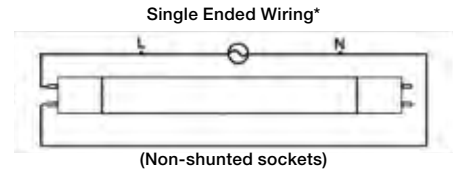

LED T8 Fluorescent Replacement Lamps



Item Number	Lamp Description	W	V	CRI	Base Type	Bm	CCT	Lm	M.O.L. (Inches)	Life/Hrs.	UPC	M/Case Qty
S11920	13.5T8/LED/48-830/DIM-BP	13.5	120	82	G13	220°	3000K	1700	48	50K	045923119200	25
S11921	13.5T8/LED/48-835/DIM-BP	13.5	120	82	G13	220°	3500K	1700	48	50K	045923119217	25
S11922	13.5T8/LED/48-840/DIM-BP	13.5	120	82	G13	220°	4000K	1800	48	50K	045923119224	25
S11923	13.5T8/LED/48-850/DIM-BP	13.5	120	82	G13	220°	5000K	1800	48	50K	045923119231	25

**See satco.com for dimmer compatibility list.

See warranty for details.

Premium LED T8 ballast bypass type B, true flicker-free lamps



- No ballast or external driver required
- Flicker free — Less than 2%
- Installation protection — will not light if ballast is not bypassed
- Low Wattage — only 11.5 watts
- High lumen — up to 2600
- Direct wire 120-277V line voltage*
- All glass tube
- PET Coated — shatterproof
- Long life: 50,000 hours
- c-UL-us Classified
- ETL Sanitation listed (conforms to NSF)
- DLC Listed
- 5 Year warranty

2 Installation Options

1. Double Ended Wiring

AC 120-277V

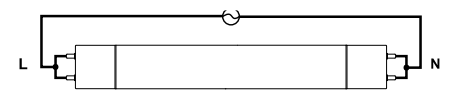

2. Single Ended Wiring

AC 120-277V

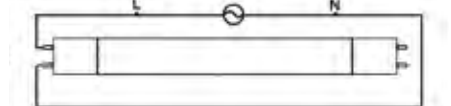

(Non-shunted sockets)



LED T8 fluorescent replacement lamps

Item Number	Lamp Description	W	CRI	Bm	CCT	Lm	M.O.L. (Inches)	Life/ Hrs.	UPC	Case Pack
S11910	11.5T8/LED/48-830/FF/BP 120-277V	11.5	80	190°	3000K	1650	48	50K	045923119101	25
S11911	11.5T8/LED/48-835/FF/BP 120-277V	11.5	80	190°	3500K	1650	48	50K	045923119118	25
S11912	11.5T8/LED/48-840/FF/BP 120-277V	11.5	80	190°	4000K	1750	48	50K	045923119125	25
S11913	11.5T8/LED/48-850/FF/BP 120-277V	11.5	80	190°	5000K	1800	48	50K	045923119132	25
S11914	18.5T8/LED/48-830/FF/BP 120-277V	18.5	80	190°	3000K	2400	48	50K	045923119149	25
S11915	18.5T8/LED/48-835/FF/BP 120-277V	18.5	80	190°	3500K	2400	48	50K	045923119156	25
S11916	18.5T8/LED/48-840/FF/BP 120-277V	18.5	80	190°	4000K	2500	48	50K	045923119163	25
S11917	18.5T8/LED/48-850/FF/BP 120-277V	18.5	80	190°	5000K	2600	48	50K	045923119170	25

Product sheet SA2527

See warranty for details.



15W Linear LED ballast bypass type B T8 series

Direct wire replacement for linear fluorescent T8 lamps in existing fixtures. Single ended wiring/non-shunted sockets.

Single ended wiring/non-shunted sockets

- No ballast or external driver required
- Direct wire 120-277V line voltage**
- All glass tube
- Damp location
- c-UL-us Classified
- DLC listed*
- Long life—50,000 hours
- 5 Year warranty



Single Ended Wiring Diagram
AC120-277V

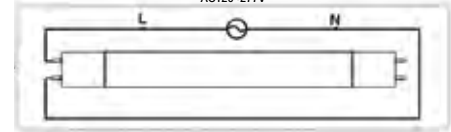

Wiring harnesses available including non-shunted sockets, sold separately

Item Number	Description
80/2626	1 LT BALLAST BYPASS WIRING HARNESS
80/2627	2 LT BALLAST BYPASS WIRING HARNESS
80/2628	3 LT BALLAST BYPASS WIRING HARNESS
80/2629	4 LT BALLAST BYPASS WIRING HARNESS

LED T8 Ballast Bypass

Item Number	Lamp Description	W	CRI	Base Type	Bm	CCT	Lm	M.O.L. (Inches)	Life/Hrs.	UPC	Pack
S9720*	15T8/LED/48-830/BP	15	82	Med Bi-Pin	230°	3000K	1700	48	50K	045923097201	10
S9721*	15T8/LED/48-835/BP	15	82	Med Bi-Pin	230°	3500K	1700	48	50K	045923097218	10
S9722*	15T8/LED/48-840/BP	15	82	Med Bi-Pin	230°	4000K	1800	48	50K	045923097225	10
S9723*	15T8/LED/48-850/BP	15	82	Med Bi-Pin	230°	5000K	1800	48	50K	045923097232	10

** Install on non-shunted lampholders



Linear LED ballast bypass type B T8 U-bend series

- No ballast or external driver required
- Direct wire 120-277V line voltage**
- All glass tube
- Damp location
- c-UL-us Classified
- DLC listed*
- Long life—50,000 hours
- 5 Year warranty



Product sheet SA1887

Wiring Diagram
AC 120-277 V

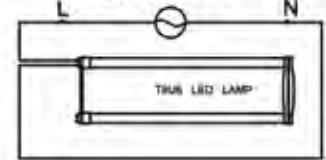

Linear LED Ballast Bypass T8 U-Bend Series

Item Number	Lamp Description	W	V	CRI	CCT	Lm	Bm	M.O.L. (Inches)	Life/Hrs.	UPC	Pack
S9930*	15T8U6/LED/22.5-830/BP	15	120-277	82	3000K	1700	220°	22 ½	50K	045923099304	12
S9931*	15T8U6/LED/22.5-835/BP	15	120-277	82	3500K	1700	220°	22 ½	50K	045923099311	12
S9932*	15T8U6/LED/22.5-840/BP	15	120-277	82	4000K	1800	220°	22 ½	50K	045923099328	12
S9933*	15T8U6/LED/22.5-850/BP	15	120-277	82	5000K	1800	220°	22 ½	50K	045923099335	12

** Install on non-shunted lampholders

Product sheet SA2189



See warranty for details.

Slimline 4', 6', 8' T8 ballast bypass type B series

- Double ended wiring
- Shatterproof coated
- Over 40% energy savings vs standard 8' T8 systems
- Slimline single pin base - replaces T8 & T12
- No ballast or external driver required
- Direct wire 120-277V line voltage
- All glass tube
- Damp location
- NSF certified
- c-UL-us Classified
- Long life—50,000 hours
- 5 Year warranty



LED T8 Ballast Bypass

Item Number	Lamp Description	W	CRI	Base Type	Bm	CCT	Lm	M.O.L. (Inches)	Life/Hrs.	UPC	Pack
S11926	14T8/LED/48-840/BP	14	80	Single Pin (FA8)	210°	4000K	1900	48	50K	045923119262	25
S11927	24T8/LED/72-840/BP	24	80	Single Pin (FA8)	210°	4000K	3200	72	50K	045923119279	10
S9917*	43T8/LED/96-835/BP	43	82	Single Pin (FA8)	210°	3500K	5500	96	50K	045923099175	10
S9918*	43T8/LED/96-840/BP	43	82	Single Pin (FA8)	210°	4000K	5500	96	50K	045923099182	10
S9919*	43T8/LED/96-850/BP	43	82	Single Pin (FA8)	210°	5000K	5500	96	50K	045923099199	10

Product sheet SA2683

43W Linear LED ballast bypass 8' type B T8 series

- Double ended wiring
- Shatterproof coated
- Over 40% energy savings vs standard 8' T8 systems
- R17d base designed to replace 8' T8 HO and T12 HO
- Fluorescent lamps
- No ballast or external driver required
- Direct wire 120-277V line voltage
- All glass tube
- Damp location
- NSF certified
- c-UL-us Classified
- Long life—50,000 hours
- 5 Year warranty

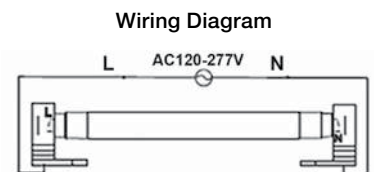

LED T8 Ballast Bypass

Item Number	Lamp Description	W	V	CRI	Base Type	Bm	CCT	Lm	M.O.L. (Inches)	Life/Hrs.	UPC	Pack
S9924	43T8/LED/96-840/BP/R17d	43	120-277V	82	R17d	210°	4000K	5500	96	50K	045923099243	10
S9925	43T8/LED/96-850/BP/R17d	43	120-277V	82	R17d	210°	5000K	5500	96	50K	045923099250	10
S9942	43T8/LED/96-865/BP/R17d	43	120-277V	82	R17d	210°	6500K	5500	96	50K	045923099427	10

Product sheet SA2611

See warranty for details.

25W, 4' Linear LED type A T5 lamps

Direct replacement for linear fluorescent F54T5HO lamps in existing fixtures with electronic ballasts.

No rewiring required*

- Over 50% energy savings vs. standard 4' T5 systems
- All glass tube • Compatible with rapid start ballasts*
- Integrated thermal fuse at pins • Damp location • NSF certified • c-UL-us listed
- DLC listed* • Long life—50,000 hours • 5 Year warranty



LED T5 Ballast Compatible

Item Number	Lamp Description	W	CRI	Base Type	Bm	CCT	Lm	Nominal (M.O.L.)	Life/ Hrs.	UPC	Pack
S29912*	25T5/LED/46-835/DR	25	82	G5	185°	3500K	3300	48 (46)	50K	045923097126	10
S29910*	25T5/LED/46-840/DR	25	82	G5	185°	4000K	3500	48 (46)	50K	045923097102	10
S29911*	25T5/LED/46-850/DR	25	82	G5	185°	5000K	3500	48 (46)	50K	045923097119	10

* May not be compatible with all rapid start ballasts. Visit www.satco.com for an approved list.

Product sheet SA2306

LED T5 Type B ballast bypass series

Double or Single ended ballast bypass replacement for linear fluorescent T5 HO & HE lamps in existing fixtures.

- No ballast or external driver required
- Available in 2', 3' & 4'
- Direct wire 120-277V line voltage
- Single or double-ended wiring
- All glass tube • PET-shatterproof coated
- Damp location
- c-UL-us classified
- NSF certified
- DLC listed*
- Long life—50,000 hours
- 5 Year warranty

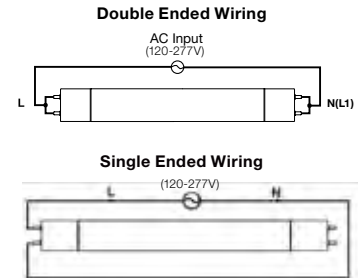

LED T5-Ballast Bypass Lamps

Item Number	Lamp Description	W	V	CRI	Base Type	Bm	CCT	Lm	Nominal Length (Inches)	Life/ Hrs.	UPC	Pk.
S28690*	13T5/LED/46-835/BP/HE/SE-DE	13	120-277	83	G5	240°	3500	1600	48	50K	045923286902	25
S28691*	13T5/LED/46-840/BP/HE/SE-DE	13	120-277	83	G5	240°	4000	1650	48	50K	045923286919	25
S28692*	13T5/LED/46-850/BP/HE/SE-DE	13	120-277	83	G5	240°	5000	1700	48	50K	045923286926	25
S28693	12T5/LED/24-835/BP/HO/SE-DE	12	120-277	83	G5	240°	3500	1400	24	50K	045923286933	25
S28694	12T5/LED/24-840/BP/HO/SE-DE	12	120-277	83	G5	240°	4000	1450	24	50K	045923286940	25
S28695	12T5/LED/24-850/BP/HO/SE-DE	12	120-277	83	G5	240°	5000	1500	24	50K	045923286957	25
S28696	16T5/LED/36-835/BP/HO/SE-DE	16	120-277	83	G5	240°	3500	1800	36	50K	045923286964	25
S28697	16T5/LED/36-840/BP/HO/SE-DE	16	120-277	83	G5	240°	4000	1850	36	50K	045923286971	25
S28698	16T5/LED/36-850/BP/HO/SE-DE	16	120-277	83	G5	240°	5000	1900	36	50K	045923286988	25
S39717*	25T5/LED/46-835/BP/HO/SE-DE	25	120-277	83	G5	240°	3500	3200	48	50K	045923397172	25
S39718*	25T5/LED/46-840/BP/HO/SE-DE	25	120-277	83	G5	240°	4000	3300	48	50K	045923397189	25
S39719*	25T5/LED/46-850/BP/HO/SE-DE	25	120-277	83	G5	240°	5000	3400	48	50K	045923397196	25

Product sheet SA2684

See warranty for details.

LED T5 mini bi-pin (G5) ballast bypass type B series

Ballast bypass replacement for
mini bi-pin linear fluorescent T5
preheat lamps in existing fixtures.

- No ballast or external driver required
- Available in 6", 9", 12", & 21"
- Direct wire 120-277V line voltage
- PET Shatterproof coated
- Damp location
- c-UL-us classified
- Long life—50,000 hours
- 5 Year warranty

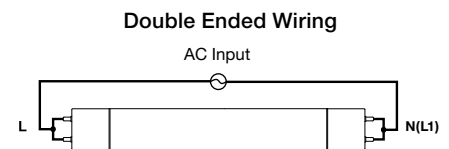

LED T5 Mini Bi-Pin Ballast Bypass Lamps

Item Number	Lamp Description	Replaces	W	V	CRI	Base Type	Bm	CCT	Lm	M.O.L. (Nominal)	Length (Inches)	Life/ Hrs.	UPC	Pack
S11900	2W/LED/T5/840	F4T5/CW	2	120-277	80	G5	240°	4000K	150	5 29/32	6	50K	045923119002	10
S11901	2W/LED/T5/865	F4T5/D	2	120-277	80	G5	240°	6500K	150	5 29/32	6	50K	045923119019	10
S11902	3W/LED/T5/840	F6T5/CW	3	120-277	80	G5	240°	4000K	270	8 29/32	9	50K	045923119026	10
S11903	3W/LED/T5/865	F6T5/D	3	120-277	80	G5	240°	6500K	270	8 29/32	9	50K	045923119033	10
S11904	4W/LED/T5/830	F8T5/WW	4	120-277	80	G5	240°	3000K	400	11 29/32	12	50K	045923119040	10
S11905	4W/LED/T5/840	F8T5/CW	4	120-277	80	G5	240°	4000K	400	11 29/32	12	50K	045923119057	10
S11906	4W/LED/T5/865	F8T5/D	4	120-277	80	G5	240°	6500K	400	11 29/32	12	50K	045923119064	10
S11907	7W/LED/T5/830	F13T5/WW	7	120-277	80	G5	240°	3000K	700	20 29/32	21	50K	045923119071	10
S11908	7W/LED/T5/840	F13T5/CW	7	120-277	80	G5	240°	4000K	700	20 29/32	21	50K	045923119088	10
S11909	7W/LED/T5/865	F13T5/D	7	120-277	80	G5	240°	6500K	700	20 29/32	21	50K	045923119095	10

Product sheet SA2463

See warranty for details.

LED T8 dual mode (ballast bypass type B/ ballast compatible type A) 1-5/8" u-bend lamps

Direct replacements for fluorescent T8 u-bend lamps in existing fixtures with or without ballasts.

- Over 50% energy savings vs. standard T8 systems
- Ballast compatible and ballast bypass in one lamp
- Bypass mode works in single or double ended wiring†
- Protection from arcing
- 120-277V in bypass mode
- Damp location
- NSF certified
- DLC 4.2 listed
- C-UL-us listed—ballast compatible
- c-UL-us Classified—ballast bypass
- Long life—50,000 hours
- 5 Year warranty



LED T8 Dual Mode U-bend Lamps—Ballast Compatible



Item Number	Lamp Description	W	CRI	CCT	Lm	M.O.L. (Inches)	Life/ Hrs.	UPC	Pack/ Mstr.
S18450	13T8/U1-G13/LED/830/DUAL	13	80	3000K	1800	22 ½	50K	045923184505	24
S18451	13T8/U1-G13/LED/835/DUAL	13	80	3500K	1800	22 ½	50K	045923184512	24
S18452	13T8/U1-G13/LED/840/DUAL	13	80	4000K	1900	22 ½	50K	045923184529	24
S18453	13T8/U1-G13/LED/850/DUAL	13	80	5000K	2000	22 ½	50K	045923184536	24

May not be compatible with all instant start, rapid start, dimmable, and emergency ballasts. Visit www.satco.com for an approved list.

Product sheet SA2462

LED T8 Dual Mode U-bend Lamps—Ballast Bypass



Item Number	Lamp Description	W	V	CRI	CCT	Lm	M.O.L. (Inches)	Life/ Hrs.	UPC	Pack/ Mstr.
S18450	13T8/U1-G13/LED/830/DUAL	13	120-277	80	3000K	1800	22 ½	50K	045923184505	24
S18451	13T8/U1-G13/LED/835/DUAL	13	120-277	80	3500K	1800	22 ½	50K	045923184512	24
S18452	13T8/U1-G13/LED/840/DUAL	13	120-277	80	4000K	1900	22 ½	50K	045923184529	24
S18453	13T8/U1-G13/LED/850/DUAL	13	120-277	80	5000K	2000	22 ½	50K	045923184536	24

Product sheet SA2462

See warranty for details.

LED T8 dual mode (ballast bypass type B/ ballast compatible type A) linear lamps

Direct replacements for fluorescent
T8 lamps in existing fixtures with or
without ballasts.

- Over 40% energy savings vs. standard T8 systems
- Ballast compatible (12W) and ballast bypass (13W) in one lamp
- Bypass mode works in single or double ended wiring**
- Protection from arcing***
- All glass tube
- Compatible with emergency and dimming ballasts*
120-277V in bypass mode
- Damp location
- PET coated
- NSF certified
- DLC 4.2 listed
- C-UL-us listed—ballast compatible
- c-UL-us Classified—ballast bypass
- Long life—50,000 hours
- 5 Year warranty



LED T8 Dual Mode Linear Lamps

Item Number	Lamp Description	W	CRI	CCT	Lm	Bm	M.O.L. (Inches)	Life/Hrs.	UPC	Pack/Master
Ballast Compatible*										
S8890	12T8/LED/48-830/DUAL/BP-DR	12	83	3000K	1800	240°	48	50K	045923088902	25
S8891	12T8/LED/48-835/DUAL/BP-DR	12	83	3500K	1800	240°	48	50K	045923088919	25
S8892	12T8/LED/48-840/DUAL/BP-DR	12	83	4000K	1900	240°	48	50K	045923088926	25
S8893	12T8/LED/48-850/DUAL/BP-DR	12	83	5000K	1900	240°	48	50K	045923088933	25

* May not be compatible with all instant start, rapid start, dimmable, and emergency ballasts. Visit www.satco.com for an approved list. Product sheet SA2316

LED T8 Dual Mode Linear Lamps



Item Number	Lamp Description	W	V	CRI	CCT	Lm	Bm	M.O.L. (Inches)	Life/Hrs.	UPC	Pack/Master
Ballast Bypass**											
S8890	13T8/LED/48-830/DUAL/BP-DR	13	120-277	83	3000K	1800	240°	48	50K	045923088902	25
S8891	13T8/LED/48-835/DUAL/BP-DR	13	120-277	83	3500K	1800	240°	48	50K	045923088919	25
S8892	13T8/LED/48-840/DUAL/BP-DR	13	120-277	83	4000K	1900	240°	48	50K	045923088926	25
S8893	13T8/LED/48-850/DUAL/BP-DR	13	120-277	83	5000K	1900	240°	48	50K	045923088933	25

* May not be compatible with all instant start, rapid start, dimmable, and emergency ballasts. Visit www.satco.com for an approved list.

** Bypass mode works wired as a single ended lamp on non-shunted sockets or as a double ended lamp on either shunted or non-shunted sockets.

Product sheet SA2316

See warranty for details.

LED T8 dual mode linear lamps

Wiring-Ballast Compatible Type A

For instant start ballasts on the approved list, ensure that LED/fluorescent sockets are wired in a shunt configuration according to manufacturer's wiring diagram.

For rapid start ballasts on the approved list, non-shunted LED/fluorescent sockets are needed and wired according to manufacturer's wiring diagram.

Wiring Options-Ballast Bypass Type B - 120-277V

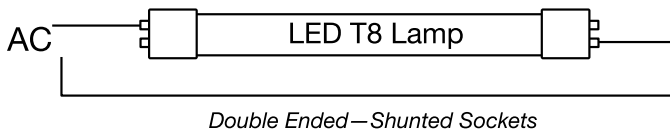
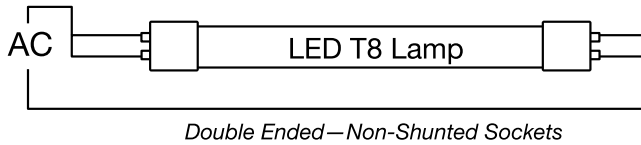
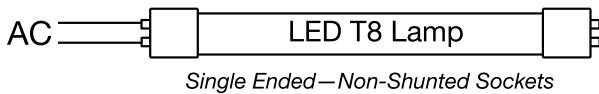

System Performance - LED T8 Dual Mode Linear Lamps—Ballast Compatible

System Performance Chart				Bare Lamp (Rated)		Bare Lamp Wattage			System Wattage			Initial Lumens			Lifetime		
Item Nmbr	Description	CCT	Length (ft)	Nominal Wattage	Nominal Lumens	LBF (0.78)	NBF (0.88)	HBF (1.18)	LBF (0.78)	NBF (0.88)	HBF (1.18)	LBF (0.78)	NBF (0.88)	HBF (1.18)	LBF (0.78)	NBF (0.88)	HBF (1.18)▼
S8890	12T8/LED/48-830/DUAL/BP-DR	3000K	4	12	1800	11.0	12.0	17	13.5	15.5	20.0	1600	1800	2500	>50Khrs	>50Khrs	50Khrs
S8891	12T8/LED/48-835/DUAL/BP-DR	3500K	4	12	1800	11.0	12.0	17	13.5	15.5	20.0	1600	1800	2500	>50Khrs	>50Khrs	50Khrs
S8892	12T8/LED/48-840/DUAL/BP-DR	4000K	4	12	1900	11.0	12.0	17	13.5	15.5	20.0	1700	1900	2600	>50Khrs	>50Khrs	50Khrs
S8893	12T8/LED/48-850/DUAL/BP-DR	5000K	4	12	1900	11.0	12.0	17	13.5	15.5	20.0	1700	1900	2600	>50Khrs	>50Khrs	50Khrs

*** Power must be turned off prior to installing lamps. Sockets must be in good working order, not broken, cracked or electrically compromised. If arcing occurs at the lamp pin, thermal fuse may activate to avoid overheating of lamp.

▼ LED tube life will change with ballast factor, configurations producing ballast factors above 1.18 are not allowed.

Product sheet SA2316

See warranty for details.

Linear LED T8, T5HO Type C system

Dedicated LED linear lamps and driver system with integral 0-10V dimming.

Features

- For retrofit and installation in new fixtures
- Driver footprint matches ballast footprint
- High efficiency
- Compatible with instant start wiring
- Low flicker design
- 120-277V, 0-10V Dimming
- 3000, 35000, 4000, 5000K
- 82 CRI
- All glass lamps, damp rated, DLC listed
- Built-in surge protection
- 50,000 hour life
- 5 Year warranty

Applications

- Replacement of existing Linear Fluorescent lamps and ballast commonly found in commercial and industrial sites, and new installations

Satco Type C systems include

- Dedicated LED lamp and driver system
- DLC rated for use in utility programs

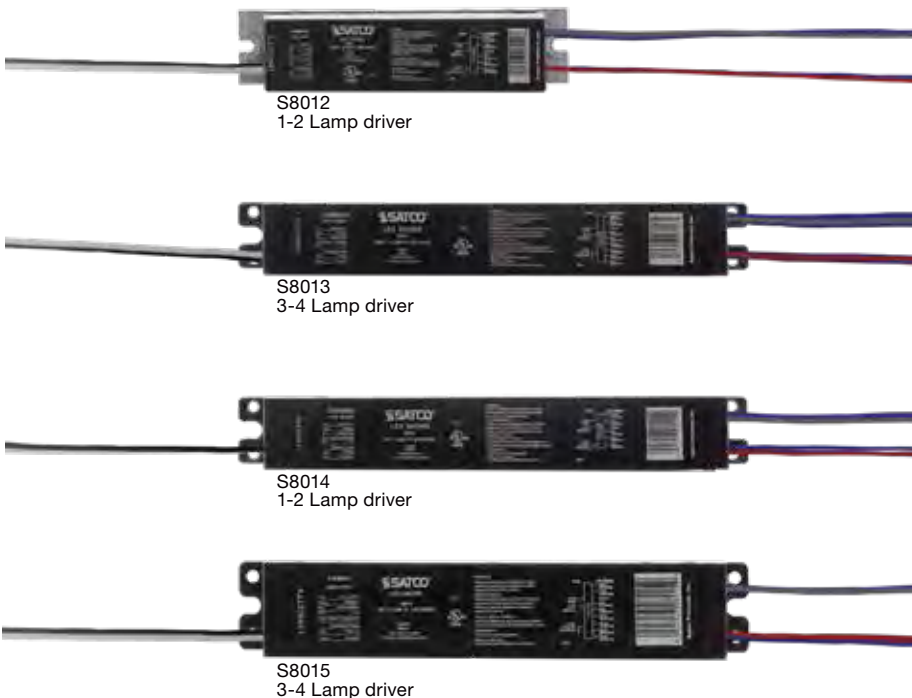

Linear LED
T8 Type C

Linear LED
T5 Type C



CFL & LINEAR FL REPLACEMENTS

Note: Fluorescent lamps are not compatible with Type C drivers

See warranty for details.



Linear LED T8 Type C lamps

Item Number	Lamp Description	W	CRI	Bulb Type	Base Type	Bm	CCT	Lm	M.O.L. (Inches)	Life/ Hrs.	UPC	M/Case Qty
2FT												
S11930	8T8/LED/24-830/XD	8	82	LED	G13	220°	3000K	1200	24	50K	045923119309	25
S11931	8T8/LED/24-835/XD	8	82	LED	G13	220°	3500K	1200	24	50K	045923119316	25
S11932	8T8/LED/24-840/XD	8	82	LED	G13	220°	4000K	1200	24	50K	045923119323	25
S11933	8T8/LED/24-850/XD	8	82	LED	G13	220°	5000K	1200	24	50K	045923119330	25
3FT												
S11934	11T8/LED/36-830/XD	11	82	LED	G13	220°	3000K	1600	36	50K	045923119347	25
S11935	11T8/LED/36-835/XD	11	82	LED	G13	220°	3500K	1600	36	50K	045923119354	25
S11936	11T8/LED/36-840/XD	11	82	LED	G13	220°	4000K	1600	36	50K	045923119361	25
S11937	11T8/LED/36-850/XD	11	82	LED	G13	220°	5000K	1600	36	50K	045923119378	25
4FT												
S11938	12T8/LED/48-830/XD	12	82	LED	G13	220°	3000K	1800	48	50K	045923119385	25
S11939	12T8/LED/48-835/XD	12	82	LED	G13	220°	3500K	1800	48	50K	045923119392	25
S11940	12T8/LED/48-840/XD	12	82	LED	G13	220°	4000K	1800	48	50K	045923119408	25
S11941	12T8/LED/48-850/XD	12	82	LED	G13	220°	5000K	1800	48	50K	045923119415	25

LED T8 Type C drivers

Item Number	Description	Lamps driven	V in	V out	Current in 120V	Current in 277V	Current out 120V, 277V	Freq. input HZ	Power factor 120V	Power factor 277V	Operating temp.	Storage temp.	UPC
S8012	LED driver/ 2', 3', 4'/Type C/T8	1, 2	120-277	24-48	300	130	290	50/60	0.95	0.93	-20° to 55°C	-40° to 85°C	045923090127
S8013	LED driver/ 2', 3', 4'/Type C/T8	3, 4	120-277	24-48	590	230	290	50/60	0.95	0.93	-20° to 55°C	-40° to 85°C	045923090134



Linear LED T5 Type C lamps

Item Number	Lamp Description	W	CRI	Bulb Type	Base Type	Bm	CCT	Lm	M.O.L. (Inches)	Life/ Hrs.	UPC	M/Case Qty
4FT T5												
S11942	23T5/LED/48-835/XD	23	82	LED	G5	220°	3500K	3500	48	50K	045923119422	25
S11943	23T5/LED/48-840/XD	23	82	LED	G5	220°	4000K	3500	48	50K	045923119439	25
S11944	23T5/LED/48-850/XD	23	82	LED	G5	220°	5000K	3500	48	50K	045923119446	25

LED T5 Type C drivers

Item Number	Description	Lamps driven	V in	V out	Current in 120V	Current in 277V	Current out 120V, 277V	Freq. input HZ	Power factor 120V	Power factor 277V	Operating temp.	Storage temp.	UPC
S8014	LED driver/4' Type C/T5	1, 2	120-277	30-48	540	240	530	50/60	0.95	0.93	-20° to 55°C	-40° to 85°C	045923080142
S8015	LED driver/4' Type C/T5	3, 4	120-277	30-45	1020	450	530	50/60	0.98	0.96	-20° to 55°C	-40° to 85°C	045923080159

8" and 12" T9 LED ballast bypass Type B Circeline lamps

- No ballast or external driver required
- Over 40% energy savings vs. standard T9 systems
- Replaces 22W and 32W fluorescent Circlines
- 120–277V (direct wire)
- Damp location
- NSF certified
- c-ETL-us listed
- Long life—50,000 hours
- 5 Year warranty

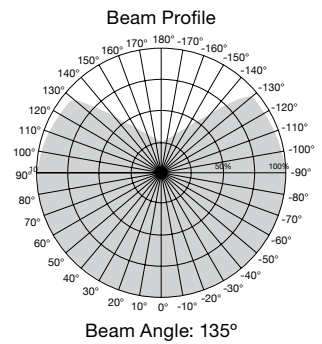
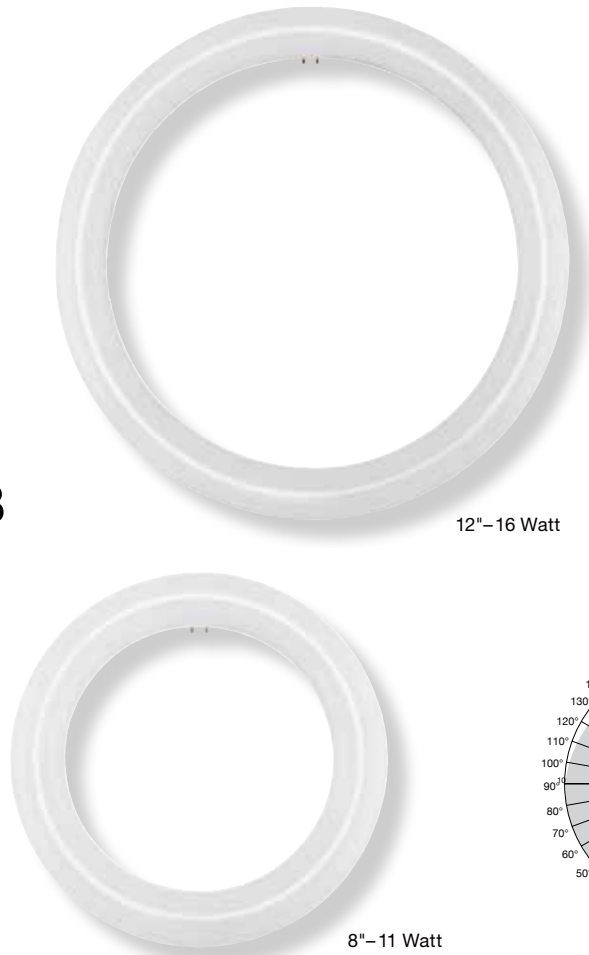

CFL & LINEAR FL REPLACEMENTS



LED T9 8" and 12" Circeline Lamps

Item Number	Lamp Description	W	CRI	Base Type	V	Bm	CCT	Lm	M.O.L. (Inches)	Life/Hrs.	UPC	Pack
S16500	FC8T9/11W/LED/CIR/830/BP	11	80	G10Q	120-277	135°	3000K	1100	8	50K	045923165009	12
S16501	FC8T9/11W/LED/CIR/840/BP	11	80	G10Q	120-277	135°	4000K	1210	8	50K	045923165016	12
S16502	FC8T9/11W/LED/CIR/865/BP	11	80	G10Q	120-277	135°	6500K	1210	8	50K	045923165023	12
S16503	FC12T9/16W/LED/CIR/830/BP	16	80	G10Q	120-277	135°	3000K	1600	12	50K	045923165030	12
S16504	FC12T9/16W/LED/CIR/840/BP	16	80	G10Q	120-277	135°	4000K	1760	12	50K	045923165047	12
S16505	FC12T9/16W/LED/CIR/865/BP	16	80	G10Q	120-277	135°	6500K	1760	12	50K	045923165054	12

Product sheet SA2461

See warranty for details.

LED Emergency Back-Up

For LED T8 and T5 ballast bypass lamps.

Features

- 5 Watt or 10 Watt output power options
- Driver type: Constant wattage LED emergency
- Approximate lumens output 500lms~1000lms
- LED test switch and indicator light included
- Operating frequency: 50/60 Hz
- Max. current: 100mA@120v / 215mA@120v
- 1.8 Watt standby power
- 90 minute battery run time
- Output and over-power protection
- Recharge 24 hours max
- Lithium Ion battery
- 120-277V input
- Damp location
- 32°F-122°F (0°C-50°C) Operating temperature
- 5 Year warranty



Compatibility

- Satco 4' T8 (S9720-S9723)
- Satco U-Bend (S9930-S9933)
- Satco 4' T5 LED bypass lamps (S29717-S29719)
- Satco 2G11 PL-L (S9950-9951)
- Satco 2' T8 (S29900-S29905)
- Satco 4' T8 (S11924, S29913-S29916)
- Satco 3' T8 (S29926-S29929)
- Satco 4' T8 (S29904-S29907)

Wiring Instructions

Single Ended Wiring

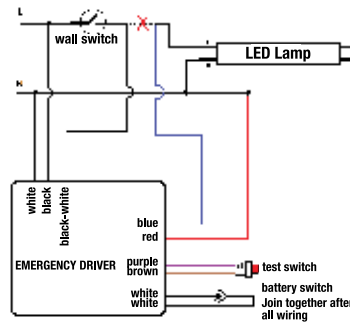

Double Ended Wiring

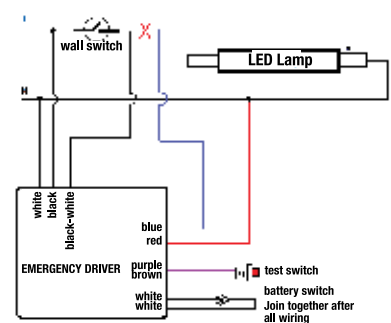

Dimensions

S8000

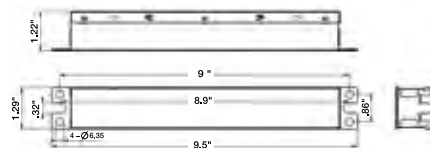

S8002

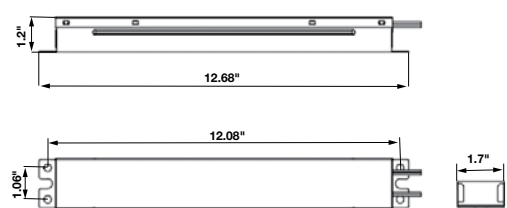

Emergency battery backup

Item #	Description	Watts	Voltage	M.O.L.	Max. Current	Dimensions	Power Factor	UPC	Case
S8000	5W Emergency LED driver	5	120-277	9.5"	100mA@120V	1.3"W x 1.22"H x 9.5"L	70.35	045923080005	25
S8002	10W Emergency LED driver	10	120-277	12.68"	215mA@120V	1.7"W x 1.20"H x 12.68"L	70.35	045923080029	12

Meets UL924, CEC Title 20, FCC15 Part 15 Class A, Compliance.

Product sheet SA2363

See warranty for details.

LED T8 Type B sign lamps extended line with new length options

- Over 40% savings vs. standard T8 systems
- 14 Length options from 2' to 10'
- Base rotates 90° for easy installation
- Full illumination for 2-way signs
- Wide, 330° beam angle • CRI >83
- No ballast and no external driver required
- Direct wire 120-277V line voltage
- Damp location • NSF Certified
- c-UL-us Classified • Long life—50,000 hours
- 5 Year warranty

Wiring Diagram - AC 120-277V
Single Ended Wiring Required

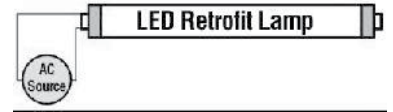

LED T8 Sign Lamps

Item Number	Lamp Description	W	CRI	Base	CCT	Lm	Nominal (MOL inches)	Life/ Hrs.	UPC	Pack/ Mstr.
S16412	7T8/LED/HO-SIGN/18-840/BP	7	83	R17D	4000K	950	18 (15.9)	50K	045923164125	10
S16413	7T8/LED/HO-SIGN/18-865/BP	7	83	R17D	6500K	950	18 (15.9)	50K	045923164132	10
S16400	9T8/LED/HO-SIGN/24-840/BP	9	83	R17D	4000K	1200	24 (21.9)	50K	045923164002	10
S16401	9T8/LED/HO-SIGN/24-865/BP	9	83	R17D	6500K	1200	24 (21.9)	50K	045923164019	10
S16414	11T8/LED/HO-SIGN/30-840/BP	11	83	R17D	4000K	1500	30 (27.9)	50K	045923164149	10
S16415	11T8/LED/HO-SIGN/30-865/BP	11	83	R17D	6500K	1500	30 (27.9)	50K	045923164156	10
S16402	12T8/LED/HO-SIGN/36-840/BP	12	83	R17D	4000K	1500	36 (33.9)	50K	045923164026	10
S16403	12T8/LED/HO-SIGN/36-865/BP	12	83	R17D	6500K	1500	36 (33.9)	50K	045923164033	10
S16416	15T8/LED/HO-SIGN/42-840/BP	15	83	R17D	4000K	2100	42 (40)	50K	045923164163	10
S16417	15T8/LED/HO-SIGN/42-865/BP	15	83	R17D	6500K	2100	42 (40)	50K	045923164170	10
S16404	18T8/LED/HO-SIGN/48-840/BP	18	83	R17D	4000K	2300	48 (46.0)	50K	045923164040	10
S16405	18T8/LED/HO-SIGN/48-865/BP	18	83	R17D	6500K	2300	48 (46.0)	50K	045923164057	10
S16406	24T8/LED/HO-SIGN/60-840/BP	24	83	R17D	4000K	3100	60 (57.9)	50K	045923164064	10
S16407	24T8/LED/HO-SIGN/60-865/BP	24	83	R17D	6500K	3100	60 (57.9)	50K	045923164071	10
S16418	26T8/LED/HO-SIGN/64-840/BP	26	83	R17D	4000K	3650	64 (61.9)	50K	045923164187	10
S16419	26T8/LED/HO-SIGN/64-865/BP	26	83	R17D	6500K	3650	64 (61.9)	50K	045923164194	10
S16408	30T8/LED/HO-SIGN/72-840/BP	30	83	R17D	4000K	4100	72 (69.9)	50K	045923164088	10
S16409	30T8/LED/HO-SIGN/72-865/BP	30	83	R17D	6500K	4100	72 (69.9)	50K	045923164095	10
S16420	32T8/LED/HO-SIGN/84-840/BP	32	83	R17D	4000K	4500	84 (81.9)	50K	045923164200	10
S16421	32T8/LED/HO-SIGN/84-865/BP	32	83	R17D	6500K	4500	84 (81.9)	50K	045923164217	10
S16410	36T8/LED/HO-SIGN/96-840/BP	36	83	R17D	4000K	5000	96 (93.9)	50K	045923164101	10
S16411	36T8/LED/HO-SIGN/96-865/BP	36	83	R17D	6500K	5000	96 (93.9)	50K	045923164118	10
S16422	42T8/LED/HO-SIGN/108-840/BP	42	83	R17D	4000K	5800	108 (105)	50K	045923164224	10
S16423	42T8/LED/HO-SIGN/108-865/BP	42	83	R17D	6500K	5800	108 (105)	50K	045923164231	10
S16424	45T8/LED/HO-SIGN/117-840/BP	45	83	R17D	4000K	6300	117 (114)	50K	045923164248	10
S16425	45T8/LED/HO-SIGN/117-865/BP	45	83	R17D	6500K	6300	117 (114)	50K	045923164255	10
S16426	48T8/LED/HO-SIGN/120-840/BP	48	83	R17D	4000K	6700	120 (117)	50K	045923164262	10
S16427	48T8/LED/HO-SIGN/120-865/BP	48	83	R17D	6500K	6700	120 (117)	50K	045923164279	10

CFL & LINEAR FL REPLACEMENTS

4' and up - shipped in full cases only

Product sheet SA2494

See warranty for details.

Circular LED module retrofit kits

Upgrades most flush mount fixtures to efficient LED light

Replaces 3 60W incandescent lamps, uses only 20 Watts

Dimmable

Dimensions: 8" W x 0.65" H

Life—30,000 hours

3 Year warranty

LED Circular light engine

All necessary hardware for installation

into a variety of flush mount fixtures

Instructions and wiring diagrams

- A. (1) circular light engine
- B. (6) small wire nuts
- C. (6) medium wire nuts
- D. (1) lock-down retaining ring & washer
- E. (3) 1" #4 screws
- F. (4 x 2 each) assorted snap-in grommets (install grommets where supply wires enter fixture for power).
- G. Wiring Diagram



Easily converts most standard flush mount fixtures to LED



Circular LED Module Retrofit Kits

Item Number	Lamp Description	W	V	CCT	CRI	Lm	Life/Hrs.	UPC	Pack
S9782	20W/LED/LIGHT ENGINE/27K/RK	20	120-277	2700K	90	1450	30K	045923097829	20/1
S9783	20W/LED/LIGHT ENGINE/30K/RK	20	120-277	3000K	90	1550	30K	045923097836	20/1
S9784	20W/LED/LIGHT ENGINE/40K/RK	20	120-277	4000K	90	1650	30K	045923097843	20/1

Product sheet SA2002

See warranty for details.



Educate consumers and increase sales!

At SATCO, we don't just bring great products to the market, we help you sell them! With powerful in-store selling tools your lighting center is both a focal point and profit center!

RETAIL SUPPORT

SATCO offers a continually expanding array of merchandise to support your in-store sales effort and create an educative and informative lighting section. From aisle flags and gondola headers to informative counter cards and shelf talkers that assist with LED technology information.

In addition, our entire library of high quality product photos and graphics are available for your use in your flyers, advertising and marketing.

COUNTER CARDS

Place these informational cards in alternate busy departments to remind customers about their lighting needs.



Left to Right Paint Department Counter Card SA1456, Energy Efficient Counter Card SA 1207, Energy Efficient Lamps and Fixtures Counter Card SA1458

RETAIL SUPPORT

BRAND AWARENESS



SATCO BRAND LOGO BANNER
SA1296

LIGHTING CENTER LOCATION TOOLS

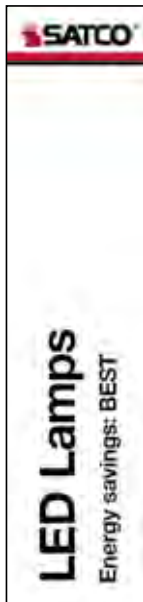

AISLE FLAGS

Assist in defining shelving sections for easy product location and stocking. Shown here, LED Lamp. Other flags available.

LED LAMP AISLE VIOLATOR TAG SA1292/4
(mounting hardware available)



LED GONDOLA HEADER SA 2006 (header mounting hardware available)

LED GONDOLA HEADER

Assists customers in easily identifying the LED products that can be found in your lighting center, helping them better understand what technologies are available for both their needs today and in the future.



LED GONDOLA SHELF STRIP SA1265/4

SHELF STRIP

Assist in product location for the stocking and finding of products.

EDUCATIONAL TOOLS

Lamp Savings Comparison-per lamp, per year*					www.satco.com
INCANDESCENT Standard Wattage	Savings for Halogen Life = 1,000 Hours	Savings for CFL Life = 10,000 Hours	Savings for LED Life = 25,000 Hours	SAVE MORE	
25W =	-	\$2.17	\$2.65	Long life = Less replacement lamps	
40W =	\$1.33	\$3.74	\$3.86		
60W =	\$2.05	\$5.66	\$6.03		
75W =	\$2.65	\$6.86	\$7.46		
100W =	\$3.38	\$9.28	\$10.00		

* Estimated yearly energy cost is based on 3 hrs/day, 6.11¢ kWh. Cost depends on rates and use.

ENERGY EFFICIENT SHELF TALKER SA1205

GONDOLA HEADER AND SHELF TALKERS

Available on a number of topics, Gondola headers and shelf talkers can help educate consumers on a number of topics pertinent to products in your lighting center, helping you sell more!

Choosing Color Temperature					www.satco.com
COLOR TEMPERATURE SCALE					
Soft White	Bright White		Natural Light		
2700K	3000K	3500K	4100K	5000K	7500K
Warm 2700K is inviting, warm, friendly and relaxing. • Homes • Restaurants	Neutral 3000K is inviting, comfortable and relaxing. • Homes • Showrooms • Reception • Offices	Cool 4100K is efficient, clean and organized. • Offices • Hospitals • Conference rooms	Daylight 5000K is exacting, refreshing, bright and alert. • Galleries • Jewelry displays	Daylight 7500K is exacting, refreshing, bright and alert. • Galleries • Jewelry displays	
Warm	Neutral	Cool	Daylight	Daylight	

CHOOSING COLOR TEMPERATURE SA1285/2 (header mounting hardware available)



ENERGY EFFICIENT SHELF TALKER SA1205

Item	Page	Item	Page	Item	Page	Item	Page
80-929.....	35, 55, 55, 70, 72, 73, 76, 77, 78, 79	S8581.....	49	S8928.....	78	S9385.....	58
80-935.....	71	S8582.....	50	S8929.....	78	S9386.....	56
80-954.....	76, 77, 80	S8583.....	51	S8930.....	78	S9387.....	56
80-955.....	80	S8584.....	52	S8950.....	41	S9388.....	56
80-956.....	76, 77, 80	S8585.....	56	S8951.....	41	S9389.....	56
80-957.....	76, 77, 80	S8588.....	58	S8952.....	41	S9400.....	49
86-215.....	73	S8589.....	58	S8953.....	41	S9401.....	49
90-483.....	81	S8598.....	49	S8980.....	78	S9402.....	49
92-406.....	70	S8600.....	61	S8987.....	78	S9403.....	49
92-410.....	35, 71, 72, 73, 78	S8601.....	61	S9004.....	60	S9404.....	49
S8000.....	106	S8603.....	56, 58, 59	S9005.....	60	S9405.....	49
S8002.....	106	S8604.....	59	S9021.....	45	S9406.....	49
S8012.....	104	S8605.....	59	S9022.....	45	S9407.....	49
S8013.....	104	S8609.....	21	S9029.....	45	S9408.....	49
S8014.....	104	S8610.....	22	S9030.....	40	S9409.....	49
S8015.....	104	S8611.....	22	S9031.....	40	S9410.....	50
S8189.....	41	S8612.....	22	S9032.....	40	S9411.....	50
S8190.....	41	S8615.....	21	S9033.....	40	S9412.....	50
S8191.....	41	S8616.....	21	S9058.....	45	S9413.....	50
S8480.....	27	S8635.....	57	S9064.....	40	S9414.....	50
S8481.....	27	S8636.....	57	S9065.....	40	S9415.....	50
S8482.....	27	S8637.....	57	S9067.....	40	S9416.....	50
S8483.....	31	S8638.....	57	S9068.....	40	S9417.....	50
S8484.....	31	S8639.....	57	S9150.....	24	S9418.....	50
S8485.....	31	S8640.....	57	S9151.....	24	S9419.....	50
S8486.....	33	S8641.....	57	S9152.....	24	S9420.....	50
S8487.....	33	S8642.....	57	S9153.....	24	S9421.....	50
S8488.....	33	S8643.....	57	S9154.....	24	S9422.....	50
S8489.....	32	S8644.....	57	S9155.....	24	S9423.....	50
S8490.....	34	S8650.....	31	S9156.....	24	S9424.....	50
S8494.....	49	S8651.....	31	S9157.....	24	S9425.....	51
S8495.....	50	S8652.....	33	S9158.....	24	S9426.....	51
S8496.....	51	S8653.....	33	S9159.....	24	S9427.....	51
S8497.....	52	S8676.....	58	S9160.....	24	S9428.....	51
S8498.....	52	S8677.....	58	S9161.....	24	S9429.....	51
S8499.....	32	S8678.....	58	S9162.....	24	S9430.....	51
S8530.....	87	S8679.....	58	S9163.....	24	S9431.....	51
S8531.....	87	S8688.....	62	S9164.....	24	S9432.....	51
S8532.....	87	S8689.....	62	S9165.....	24	S9433.....	51
S8533.....	87	S8735.....	35	S9166.....	24	S9434.....	51
S8534.....	87	S8736.....	35	S9167.....	24	S9435.....	51
S8535.....	87	S8737.....	35	S9168.....	24	S9436.....	51
S8536.....	87	S8738.....	35	S9169.....	24	S9437.....	51
S8537.....	87	S8745.....	89	S9170.....	24	S9438.....	51
S8538.....	87	S8746.....	89	S9171.....	24	S9439.....	51
S8539.....	87	S8747.....	89	S9172.....	24	S9440.....	52
S8542.....	38	S8748.....	89	S9173.....	24	S9441.....	52
S8543.....	38	S8749.....	89	S9174.....	24	S9442.....	52
S8544.....	38	S8755.....	89	S9175.....	24	S9443.....	52
S8545.....	38	S8756.....	89	S9176.....	24	S9444.....	52
S8550.....	7	S8757.....	89	S9177.....	24	S9445.....	52
S8551.....	15	S8758.....	89	S9200.....	41	S9446.....	52
S8552.....	16	S8759.....	89	S9201.....	41	S9447.....	52
S8553.....	11	S8778.....	35	S9202.....	41	S9448.....	52
S8554.....	17	S8779.....	35	S9203.....	41	S9449.....	52
S8555.....	17	S8839.....	14	S9280.....	56	S9450.....	52
S8556.....	17	S8840.....	16	S9281.....	56	S9451.....	52
S8559.....	17	S8841.....	17	S9282.....	56	S9452.....	52
S8564.....	32	S8849.....	12	S9283.....	56	S9453.....	52
S8565.....	32	S8851.....	17	S9316.....	38	S9454.....	52
S8566.....	34	S8890.....	101	S9317.....	38	S9455.....	52
S8567.....	34	S8891.....	101	S9318.....	38	S9456.....	52
S8568.....	34	S8892.....	101	S9319.....	38	S9457.....	52
S8570.....	38	S8893.....	101	S9380.....	58	S9480.....	52
S8571.....	38	S8914.....	26	S9381.....	58	S9481.....	52
S8572.....	40	S8915.....	26	S9382.....	58	S9482.....	52
S8573.....	40	S8916.....	26	S9383.....	58	S9483.....	52
		S8920.....	26	S9384.....	58	S9484.....	52

Item	Page	Item	Page	Item	Page	Item	Page
S9485	49	S9641	44	S9963	16	S11365	12
S9486	50	S9698	44	S9964	14, 15	S11366	12
S9487	51	S9703	27	S9965	16	S11367	13
S9488	52	S9704	27	S9966	19	S11368	13
S9490	57	S9707	27	S9967	19	S11369	14
S9491	57	S9708	27	S9968	19	S11370	14
S9492	57	S9720	96	S9969	19	S11371	14
S9493	57	S9721	96	S9970	19	S11372	14
S9494	57	S9722	96	S9971	19	S11373	14
S9495	57	S9723	96	S9980	60	S11374	15
S9496	57	S9729	67	S9981	60	S11375	15
S9497	57	S9753	72	S9982	60	S11376	16
S9498	57	S9754	72	S9983	60	S11377	16
S9499	57	S9755	72	S9986	18	S11378	17
S9542	61	S9760	55	S9987	18	S11379	17
S9543	61	S9761	55	S9994	91	S11380	17
S9544	61	S9762	55	S9995	91	S11381	17
S9545	61	S9763	55	S9996	91	S11382	17
S9546	61	S9764	55	S9997	91	S11400	30
S9547	61	S9765	55	S11210	62	S11401	30
S9550	56	S9779	72	S11211	62	S11402	25
S9551	56	S9782	108	S11212	62	S11403	25
S9552	57	S9783	108	S11213	62	S11404	25
S9553	57	S9784	108	S11214	62	S11405	25
S9564	12	S9806	37	S11215	62	S11406	26
S9565	13	S9807	17	S11216	62	S11407	26
S9566	13	S9826	8	S11217	62	S11408	26
S9567	15	S9827	12	S11300	23	S11409	26
S9569	15	S9828	12	S11301	23	S11410	30
S9571	16	S9845	9	S11302	23	S11411	30
S9575	17	S9846	9	S11303	23	S11412	30
S9576	17	S9854	86	S11304	23	S11413	30
S9577	18	S9855	86	S11305	23	S11414	28
S9578	18	S9856	86	S11306	23	S11415	28
S9579	18	S9857	86	S11307	23	S11416	28
S9580	17	S9862	86	S11310	31	S11417	28
S9581	17	S9863	86	S11311	31	S11420	45
S9582	17	S9864	86	S11320	25	S11421	37
S9583	18	S9865	86	S11321	25	S11423	34
S9584	18	S9868	14	S11323	31	S11424	34
S9585	18	S9869	16	S11324	31	S11425	34
S9588	18	S9870	11	S11325	31	S11500	9
S9590	25	S9872	17	S11326	33	S11501	9
S9591	25	S9873	18	S11327	33	S11502	9
S9592	25	S9892	17	S11328	33	S11503	10
S9593	26	S9893	12	S11329	34	S11504	10
S9594	26	S9895	17	S11330	34	S11505	9
S9595	26	S9917	97	S11331	34	S11506	9
S9598	67	S9918	97	S11332	34	S11507	9
S9599	67	S9919	97	S11333	43	S11508	10
S9616	57	S9924	97	S11334	57	S11509	10
S9620	43	S9925	97	S11335	57	S11510	9
S9621	43	S9930	96	S11336	57	S11511	9
S9622	43	S9931	96	S11350	7	S11512	9
S9623	43	S9932	96	S11351	7	S11513	10
S9624	43	S9933	96	S11352	7	S11514	10
S9627	43	S9942	97	S11353	7	S11540	42
S9630	43	S9946	91	S11354	7	S11541	42
S9631	43	S9947	91	S11355	8	S11542	42
S9632	43	S9948	91	S11356	8	S11543	42
S9633	43	S9949	91	S11357	9	S11550	85
S9634	44	S9950	90	S11358	9	S11551	85
S9635	44	S9951	90	S11359	9	S11552	85
S9636	44	S9952	90	S11360	9	S11553	85
S9637	44	S9953	90	S11361	9	S11554	85
S9638	44	S9960	14	S11362	9	S11800	63
S9639	44	S9961	14	S11363	11	S11801	63
S9640	44	S9962	16	S11364	11	S11820	63

Item	Page	Item	Page	Item	Page	Item	Page
S11821	63	S12242	54	S16503	105	S21804	39
S11822	63	S12243	54	S16504	105	S21805	39
S11824	63	S12250	54	S16505	105	S21806	39
S11825	63	S12251	54	S18400	84	S21807	39
S11900	99	S12252	54	S18401	84	S22431	20
S11901	99	S12253	54	S18402	84	S22432	20
S11902	99	S29761	54	S18403	84	S22433	20
S11903	99	S13100	36	S18404	84	S22703	23
S11904	99	S13101	36	S18450	100	S22707	23
S11905	99	S13102	36	S18451	100	S22712	23
S11906	99	S13103	36	S18452	100	S22713	23
S11907	99	S13104	36	S18453	100	S23403	23
S11908	99	S13105	36	S21100	7	S23407	23
S11909	99	S13106	36	S21101	7	S23412	23
S11910	95	S13107	36	S21102	7	S23413	23
S11911	95	S13108	36	S21103	7	S28491	43
S11912	95	S13109	36	S21104	7	S28492	43
S11913	95	S13110	36	S21400	88	S28493	44
S11914	95	S13111	36	S21401	88	S28547	43
S11915	95	S13113	79	S21402	88	S28557	25
S11916	95	S13114	79	S21403	88	S28558	25
S11917	95	S13115	79	S21404	88	S28560	28
S11920	94	S13118	74	S21405	88	S28561	28
S11921	94	S13119	74	S21406	88	S28562	28
S11922	94	S13120	76	S21407	88	S28563	28
S11923	94	S13121	76	S21700	21	S28574	41
S11924	93	S13122	76	S21701	21	S28575	41
S11926	97	S13123	75	S21702	21	S28576	41
S11927	97	S13124	75	S21703	21	S28577	43
S11930	104	S14984	39	S21704	21	S28578	43
S11931	104	S14985	39	S21705	21	S28579	43
S11932	104	S14986	39	S21706	21	S28580	44
S11933	104	S14987	39	S21707	21	S28593	25
S11934	104	S14988	39	S21708	14	S28594	25
S11935	104	S14989	39	S21709	15	S28595	41
S11936	104	S15011	27	S21710	21	S28596	43
S11937	104	S15012	27	S21711	21	S28597	44
S11938	104	S16400	107	S21712	10	S28602	61
S11939	104	S16401	107	S21713	10	S28613	21
S11940	104	S16402	107	S21714	10	S28614	22
S11941	104	S16403	107	S21720	22	S28617	41
S11942	104	S16404	107	S21721	22	S28618	41
S11943	104	S16405	107	S21722	22	S28619	43
S11944	104	S16406	107	S21723	22	S28680	61
S12100	11	S16407	107	S21724	22	S28681	61
S12101	11	S16408	107	S21725	22	S28682	61
S12102	11	S16409	107	S21726	22	S28683	61
S12103	11	S16410	107	S21727	22	S28684	62
S12104	11	S16411	107	S21728	21	S28685	62
S12105	11	S16412	107	S21729	14	S28686	62
S12106	12	S16413	107	S21730	21	S28687	62
S12107	12	S16414	107	S21731	22	S28690	98
S12108	12	S16415	107	S21732	22	S28691	98
S12109	12	S16416	107	S21733	21	S28692	98
S12110	12	S16417	107	S21734	10	S28693	98
S12111	13	S16418	107	S21735	22	S28694	98
S12112	13	S16419	107	S21736	22	S28695	98
S12113	13	S16420	107	S21737	12	S28696	98
S12210	53	S16421	107	S21738	12	S28697	98
S12211	53	S16422	107	S21739	12	S28698	98
S12212	53	S16423	107	S21740	12	S28710	71
S12213	53	S16424	107	S21741	59	S28711	71
S12214	53	S16425	107	S21742	59	S28712	71
S12215	53	S16426	107	S21743	59	S28713	71
S12216	53	S16427	107	S21800	39	S28714	71
S12217	53	S16500	105	S21801	39	S28715	71
S12240	54	S16501	105	S21802	39	S28716	71
S12241	54	S16502	105	S21803	39	S28717	71



Item	Page	Item	Page	Item	Page	Item	Page
S28725.....	84	S29440.....	48	S29851.....	86	S39671.....	70
S28726.....	84	S29441.....	48	S29852.....	86	S39672.....	70
S28727.....	84	S29442.....	48	S29853.....	86	S39673.....	70
S28728.....	84	S29443.....	48	S29858.....	86	S39674.....	70
S28729.....	84	S29444.....	48	S29859.....	86	S39675.....	70
S28765.....	31	S29445.....	48	S29860.....	86	S39676.....	70
S28766.....	31	S29446.....	48	S29861.....	86	S39677.....	70
S28767.....	31	S29447.....	48	S29866.....	14	S39679.....	73
S28768.....	31	S29448.....	48	S29867.....	16	S39713.....	64
S28769.....	32	S29449.....	48	S29871.....	11	S39714.....	64
S28770.....	32	S29450.....	48	S29874.....	7	S39715.....	64
S28785.....	33	S29451.....	48	S29875.....	7	S39716.....	64
S28786.....	33	S29452.....	48	S29876.....	8	S39717.....	98
S28787.....	33	S29453.....	48	S29877.....	14	S39718.....	98
S28788.....	33	S29454.....	48	S29878.....	12	S39719.....	98
S28789.....	34	S29455.....	48	S29879.....	8	S39724.....	65
S28790.....	34	S29456.....	48	S29890.....	14	S39725.....	65
S28850.....	8	S29457.....	48	S29891.....	16	S39726.....	65
S28931.....	77	S29548.....	61	S29894.....	8	S39727.....	65
S28932.....	77	S29549.....	61	S29900.....	93	S39738.....	70
S28937.....	77	S29558.....	28	S29901.....	93	S39739.....	70
S28938.....	77	S29563.....	12	S29902.....	93	S39740.....	65
S28976.....	83	S29589.....	28	S29903.....	93	S39741.....	65
S29188.....	45	S29596.....	28	S29904.....	93	S39742.....	65
S29312.....	66	S29597.....	28	S29905.....	93	S39743.....	65
S29313.....	66	S29614.....	43	S29906.....	93	S39744.....	64
S29314.....	66	S29615.....	44	S29907.....	93	S39745.....	65
S29315.....	66	S29618.....	41	S29910.....	98	S39750.....	73
S29400.....	46	S29619.....	41	S29911.....	98	S39751.....	73
S29401.....	46	S29625.....	43	S29912.....	98	S39752.....	73
S29402.....	46	S29626.....	43	S29913.....	93	S39756.....	68
S29403.....	46	S29628.....	45	S29914.....	93	S39757.....	68
S29404.....	46	S29629.....	29	S29915.....	93	S39758.....	68
S29405.....	46	S29697.....	61	S29916.....	93	S39759.....	68
S29406.....	46	S29699.....	29	S29920.....	14	S39768.....	73
S29407.....	46	S29760.....	54	S29921.....	16	S39769.....	73
S29408.....	46	S29761.....	54	S29922.....	14	S39770.....	69
S29409.....	46	S29764.....	54	S29923.....	16	S39771.....	69
S29410.....	47	S29765.....	54	S29926.....	93	S39772.....	69
S29411.....	47	S29804.....	31	S29927.....	93	S39773.....	69
S29412.....	47	S29805.....	33	S29928.....	93	S39798.....	73
S29413.....	47	S29810.....	31	S29929.....	93	S39799.....	73
S29414.....	47	S29811.....	31	S29988.....	11	S39809.....	8
S29415.....	47	S29812.....	31	S29990.....	91	S39825.....	8
S29416.....	47	S29813.....	31	S29991.....	91	S39847.....	64
S29417.....	47	S29814.....	31	S29992.....	91	S39848.....	65
S29418.....	47	S29815.....	33	S29993.....	91	S39934.....	92
S29419.....	47	S29816.....	33	S38939.....	82	S39935.....	92
S29420.....	47	S29817.....	33	S38946.....	82	S39936.....	92
S29421.....	47	S29818.....	33	S38975.....	82	S39937.....	92
S29422.....	47	S29819.....	33	S39390.....	70	S39975.....	92
S29423.....	47	S29824.....	7	S39391.....	70	S39976.....	92
S29424.....	47	S29830.....	25	S39392.....	70	S39977.....	92
S29425.....	47	S29831.....	25	S39393.....	70	S39978.....	92
S29426.....	47	S29832.....	25	S39394.....	70		
S29427.....	47	S29833.....	25	S39395.....	70		
S29428.....	47	S29834.....	25	S39396.....	70		
S29429.....	47	S29835.....	26	S39397.....	70		
S29430.....	47	S29836.....	26	S39463.....	64		
S29431.....	47	S29837.....	26	S39464.....	64		
S29432.....	47	S29838.....	26	S39465.....	64		
S29433.....	47	S29839.....	26	S39466.....	64		
S29434.....	47	S29840.....	26	S39467.....	64		
S29435.....	47	S29841.....	26	S39468.....	64		
S29436.....	47	S29842.....	26	S39472.....	65		
S29437.....	47	S29843.....	26	S39473.....	65		
S29438.....	47	S29844.....	26	S39474.....	65		
S29439.....	47	S29850.....	86	S39670.....	70		



To learn more about Satco | Nuvo,
visit satco.com or contact 800-437-2826.

DISTRIBUTION CENTERS

New York (Headquarters)

110 Heartland Blvd., Brentwood, NY 11717
Tel. 631-243-2022, Fax: 631-243-2027

Texas

2000 Valwood Parkway, Farmers Branch, TX 75234
Tel. 972-247-2437, Fax: 972-247-5408

Florida

900 N.W. 159th Drive, Miami, FL 33169
Tel. 305-624-2044, Fax: 305-623-0286

California

31288 San Benito Street, Hayward, CA 94544
Tel. 510-487-4822, Fax: 510-487-8955

Washington

4710 116th S.W., Mukilteo, WA 98275
Tel. 425-789-3300, Fax: 425-789-3310

Puerto Rico

Campeche Street. 23 Julio
N. Matos Industrial Park, Carolina, PR 00984
Tel. 787-757-3510, Fax: 787-757-3540